

aerospace  
climate control  
**electromechanical**  
filtration  
fluid & gas handling  
hydraulics  
pneumatics  
process control  
sealing & shielding

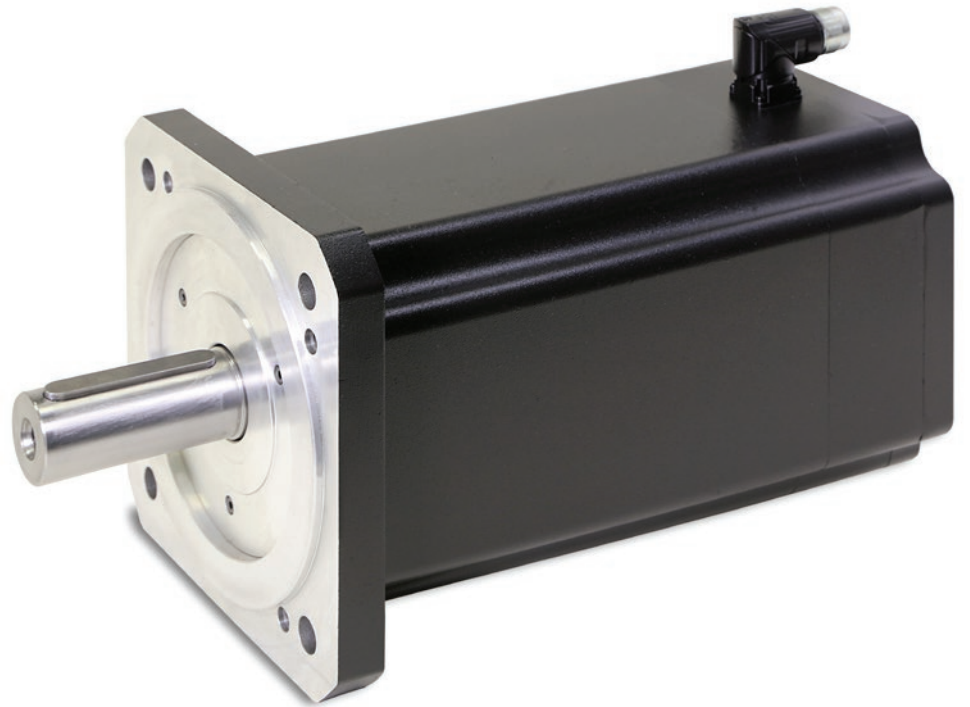

## SMH / SMB Series

Low Inertia Servo Motors

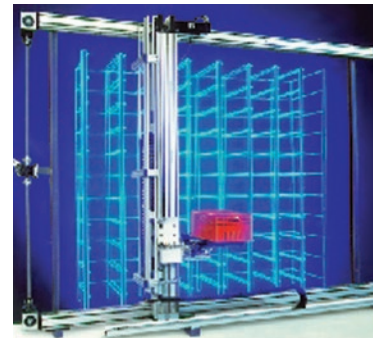

ENGINEERING YOUR SUCCESS.



**WARNING – USER RESPONSIBILITY**

**FAILURE OR IMPROPER SELECTION OR IMPROPER USE OF THE PRODUCTS DESCRIBED HEREIN OR RELATED ITEMS CAN CAUSE DEATH, PERSONAL INJURY AND PROPERTY DAMAGE.**

- This document and other information from Parker-Hannifin Corporation, its subsidiaries and authorized distributors provide product or system options for further investigation by users having technical expertise.
- The user, through its own analysis and testing, is solely responsible for making the final selection of the system and components and assuring that all performance, endurance, maintenance, safety and warning requirements of the application are met. The user must analyze all aspects of the application, follow applicable industry standards, and follow the information concerning the product in the current product catalog and in any other materials provided from Parker or its subsidiaries or authorized distributors.
- To the extent that Parker or its subsidiaries or authorized distributors provide component or system options based upon data or specifications provided by the user, the user is responsible for determining that such data and specifications are suitable and sufficient for all applications and reasonably foreseeable uses of the components or systems.

<b>Overview</b> .....	<b>5</b>
<b>Technical Characteristics</b> .....	<b>6</b>
Technical Data.....	6
Speed Torque Curves .....	8
Dimensions of Standard Motors with Resolver Feedback .....	11
<b>Options</b> .....	<b>12</b>
Holding Brake .....	12
Medium Inertia.....	12
Feedback.....	12
<b>Layout and Connectors</b> .....	<b>15</b>
<b>Associated Drives</b> .....	<b>17</b>
<b>Order Code</b> .....	<b>18</b>
Serie SMH /SMB / SME .....	18
Motor Power Cable for SMH /SMB Motors.....	20
Feedback Cable for SMH / SMB Motors .....	21

# Parker Hannifin

## The global leader in motion and control technologies

### A world class player on a local stage

#### Global Product Design

Parker Hannifin has more than 40 years experience in the design and manufacturing of drives, controls, motors and mechanical products. With dedicated global product development teams, Parker draws on industry-leading technological leadership and experience from engineering teams in Europe, North America and Asia.

#### Local Application Expertise

Parker has local engineering resources committed to adapting and applying our current products and technologies to best fit our customers' needs.

#### Manufacturing to Meet Our Customers' Needs

Parker is committed to meeting the increasing service demands that our customers require to succeed in the global industrial market. Parker's manufacturing teams seek continuous improvement through the implementation of lean manufacturing methods throughout the process. We measure ourselves on meeting our customers' expectations of quality and delivery, not just our own. In order to meet these expectations, Parker operates and continues to invest in our manufacturing facilities in Europe, North America and Asia.

#### Electromechanical Worldwide Manufacturing Locations

##### Europe

Littlehampton, United Kingdom  
Dijon, France  
Offenburg, Germany  
Filderstadt, Germany  
Milan, Italy

##### Asia

Wuxi, China  
Jangan, Korea  
Chennai, India

##### North America

Rohnert Park, California  
Irwin, Pennsylvania  
Charlotte, North Carolina  
New Ulm, Minnesota



Offenburg, Germany

#### Local Manufacturing and Support in Europe

Parker provides sales assistance and local technical support through a network of dedicated sales teams and authorized technical distributors throughout Europe.

For contact information, please refer to the Sales Offices on the back cover of this document or visit [www.parker.com](http://www.parker.com)



Milan, Italy



Littlehampton, UK



Filderstadt, Germany



Dijon, France

# Low Inertia Servo Motors - SMH / SMB

## Overview

### Description

The SMH / SMB Series of highly-dynamic brushless servo motors have been design to combine the cutting-edge technology of Parker Hannifin products with an extremely high performance.

Thanks to the innovative "salient pole" technology, the motor's dimensions are considerably reduced with significant advantages in terms of specific torque, overall dimensions and dynamic performance. Compared to traditional-technology brushless servo motors, the specific torque is approximately 30 % higher, overall dimensions are considerably reduced and, consequently rotor inertias are extremely low. Thanks to the high quality of Neodymium-Iron-Boron magnets, and also the encapsulation method used to fasten them to the shaft, the SMH/B motors can achieve very high acceleration and withstand high overloads without risk of demagnetisation or detachment of the magnets.

Specific applications for the SMH/B Series include all types especially those for the packaging and handling industry, and all those applications where very high dynamic performances and very low inertias are required.

### Features

- High number of feedback options
- Customised windings/voltages
- Increased Inertia option
- Multiple connection options

### Application

- Food, Pharma & Beverage
- Packaging Machines
- Material Forming
- Material Handling
- Factory Automation
- Life Science Diagnostic
- Automotive Industry / In-Plant
- Printing Industry
- Textile Machines
- Robotics
- Servo Hydraulic Pumps



### Technical Characteristics - Overview

<b>Motor Type</b>	Permanent magnets synchronous servomotor
<b>Rotor Design</b>	Rotor with surface rare earth magnets
<b>Number of poles</b>	8
<b>Power Range</b>	0.1 – 9.4 kW
<b>Torque Range</b>	0.19 – 60 Nm
<b>Speed Range</b>	0 – 7500 min <sup>-1</sup>
<b>Mounting</b>	Flange with smooth holes
<b>Shaft End</b>	Plain keyed shaft Plain smooth shaft (option)
<b>Cooling</b>	Natural ventilation
<b>Protection Level (IEC60034-5)</b>	IP64 IP65 (option/standard for SM_170)
<b>Feedback sensor</b>	Resolver Absolute Endat or Hiperface Incremental Encoder
<b>Thermal protection</b>	PTC for SMB and KTY compatible with SMH
<b>Other options</b>	Brake Second shaft Increased inertia
<b>Marking</b>	CE UL (SM_40 and SM_170 excluded)
<b>Voltage Supply</b>	80 / 230 / 400 VAC other voltage under request
<b>Temperature Class</b>	Class F
<b>Connections</b>	Rotatable connectors Flying cables Terminal Box (see table option for combination) Special connector (under request)

# Technical Characteristics

## Technical Data

### 230 VAC supply voltage

Model	Size	Stall <sup>(1)</sup>		Nominal <sup>(1)</sup>			Peak <sup>(1)</sup>	Inertia		Ke <sup>(2) (3)</sup>	Kt <sup>(2) (3)</sup>
		Torque	Current	Torque	Speed	Current	Torque	No brake	With brake		
		T <sub>065</sub> (T <sub>105</sub> ) [Nm]	I <sub>065</sub> [A]	T <sub>n065</sub> [Nm]	n [min <sup>-1</sup> ]	I <sub>n065</sub> [A]	T <sub>max</sub> [Nm]	J [kgmm <sup>2</sup> ]	J [kgmm <sup>2</sup> ]	Ke [Vs]	Kt [Nm/A <sub>rms</sub> ]
SM_40 60 0,19	40	0.19	0.78	0.16	6000	0.66	0.6	3.7	-	0.14	0.242
SM_40 60 0,38		0.38	1.2	0.27	6000	0.86	1.17	6.1		0.181	0.31
SM_60 30 0,55	60	0.55 (0.68)	0.7	0.50	3000	0.66	1.7	18	30.5	0.44	0.76
SM_60 45 0,55			1.0	0.39	4500	0.74				0.30	0.53
SM_60 60 0,55			1.4	0.24	6000	0.60				0.23	0.40
SM_60 16 1,4		1.4 (1.7)	0.95	1.35	1600	0.91	4.4	30	42.5	0.85	1.48
SM_60 30 1,4			1.73	1.20	3000	1.50				0.47	0.81
SM_60 45 1,4			2.37	1.00	4500	1.69				0.34	0.59
SM_60 60 1,4			2.98	0.80	6000	1.70				0.27	0.47
SM_60 75 1,4			3.85	0.15	7500	0.41				0.21	0.36
SM_82 10 03	82	3 (3.7)	1.2	2.9	1000	1.2	9	140	183	1.43	2.48
SM_82 16 03			1.8	2.9	1600	1.7				0.96	1.66
SM_82 30 03			3.1	2.7	3000	2.8				0.55	0.96
SM_82 33 03			3.5	2.4	3300	2.8				0.49	0.85
SM_82 45 03			4.7	2.2	4500	3.4				0.37	0.64
SM_82 60 03			6.1	1.5	6000	3.1				0.28	0.49
SM_82 75 03			7.5	0.6	7500	1.6				0.23	0.40
SM_100 16 06	100	6 (9)	3.7	5.8	1600	3.6	18	336	440	0.92	1.60
SM_100 30 06			5.9	5.0	3000	4.9				0.59	1.02
SM_100 45 06			9.4	3.5	4500	5.5				0.37	0.64
SM_100 55 06			11.8	2.6	5500	5.1				0.29	0.51
SM_100 75 06			14.7	0.6	7500	1.5				0.24	0.41
SM_115 16 10	115	10 (12.5)	6.0	9.0	1600	5.4	32	900	1000	0.96	1.66
SM_115 30 10			10.5	8.0	3000	8.4				0.55	0.95
SM_115 40 10			14.7	7.6	4000	11.2				0.39	0.68
SM_115 54 10			18.2	7.1	5400	12.9				0.32	0.55
SM_142 18 15	142	15 (19)	9.7	13.3	1800	8.6	47	1400	1600	0.89	1.54
SM_142 30 15			16.0	12.5	3000	13.4				0.54	0.94
SM_170 11 35	170	35	13.3	30	1100	11.4	111	2900	4500	1.52	2.6
SM_170 16 35			20	28	1600	16.0				1.03	1.8
SM_170 25 35			29	26	2500	22.0				0.69	1.2

<sup>(1)</sup> Data referred to motor mounted on a steel flange in horizontal position with resolver and without brake. Stall torques refer to motor turning at 100 min<sup>-1</sup>

<sup>(2)</sup> Data measured at 20 °C. When "hot" consider -0.09 %/K derating

<sup>(3)</sup> Manufacturing tolerance ±10 %

400 VAC power supply

Model	Size	Stall <sup>(1)</sup>		Nominal <sup>(1)</sup>			Peak <sup>(1)</sup>	Inertia		Ke <sup>(2) (3)</sup>	Kt <sup>(2) (3)</sup>
		Torque	Current	Torque	Speed	Current	Torque	No brake	With brake		
		T <sub>065</sub> (T <sub>105</sub> ) [Nm]	I <sub>065</sub> [A]	T <sub>n065</sub> [Nm]	n [min <sup>-1</sup> ]	I <sub>n065</sub> [A]	T <sub>max</sub> [Nm]	J [kgmm <sup>2</sup> ]	J [kgmm <sup>2</sup> ]	Ke [Vs]	Kt [Nm/A <sub>rms</sub> ]
SM_60 30 1,4	60	1.4 (1.7)	0.95	1.2	3000	0.81	4.4	30	42.5	0.81	1.48
SM_60 45 1,4			1.37	1.0	4500	0.98				0.59	1.02
SM_60 60 1,4			1.73	0.8	6000	0.99				0.68	0.81
SM_60 75 1,4			2.15	0.15	7500	0.23				0.38	0.65
SM_82 30 03	82	3 (3.7)	1.8	2.7	3000	1.6	9	140	183	0.96	1.66
SM_82 45 03			2.7	2.2	4500	2.0				0.64	1.11
SM_82 56 03			3.1	1.6	5600	1.7				0.55	0.96
SM_82 60 03			3.5	1.7	6000	2.0				0.49	0.85
SM_82 75 03			4.4	0.6	7500	0.9				0.39	0.68
SM_100 30 06	100	6 (9)	3.7	5.0	3000	3.1	18	336	440	0.92	1.60
SM_100 45 06			5.6	3.5	4500	3.3				0.62	1.07
SM_100 56 06			5.9	2.5	5600	2.4				0.59	1.02
SM_100 75 06			9.4	0.6	7500	0.9				0.37	0.64
SM_115 20 10	115	10 (12.5)	4.5	9.0	2000	4.06	32	900	1000	1.28	2.22
SM_115 30 10			6.0	8.0	3000	4.82				0.96	1.66
SM_115 40 10			8.0	7.6	4000	6.05				0.73	1.26
SM_115 56 10			10.5	6.0	5600	6.30				0.55	0.95
SM_142 20 15	142	15 (19)	6.4	13.0	2000	5.5	47	1400	1600	1.36	2.35
SM_142 30 15			9.7	12.5	3000	8.1				0.89	1.54
SM_142 45 15			14.4	10.9	4500	10.5				0.60	1.04
SM_142 56 15			16.0	9.2	5600	9.8				0.54	0.94
SM_142 10 17		17 (21)	3.5	16.4	1000	3.4	54			2.83	4.90
SM_142 30 17			9.6	14.0	3000	8.1				1.02	1.77
SM_142 56 17			15.8	10.6	5600	9.8				0.62	1.08
SM_170 10 35			170	35	6.8	31				1000	6.1
SM_170 20 35	13.3	27			2000	10.3	1.52	2.6			
SM_170 27 35	18	22			2700	11	1.15	2.0			
SM_170 30 35	20	19			3000		1.03	1.8			
SM_170 10 60	60	11.7		53	1000	10.4	190	5800	7400	2.95	5.1
SM_170 20 60		22.6		44	2000	16.6				1.53	2.7
SM_170 30 60		35.7		30	3000	17.9				0.97	1.7

<sup>(1)</sup> Data referred to motor mounted on a steel flange in horizontal position with resolver and without brake. Stall torques refer to motor turning at 100 min<sup>-1</sup>

<sup>(2)</sup> Data measured at 20 °C. When "hot" consider -0.09 %/K derating

<sup>(3)</sup> Manufacturing tolerance data ±10 %

**STANDARDS**

In compliance with: 2006/95 EC

- EN60034-1
- EN60034-5
- EN60034-5/A1

Marked  Marked  (except SM\_40 and SM\_170)

## Speed Torque Curves

### SMH/B60

4500 min<sup>-1</sup> 230 V

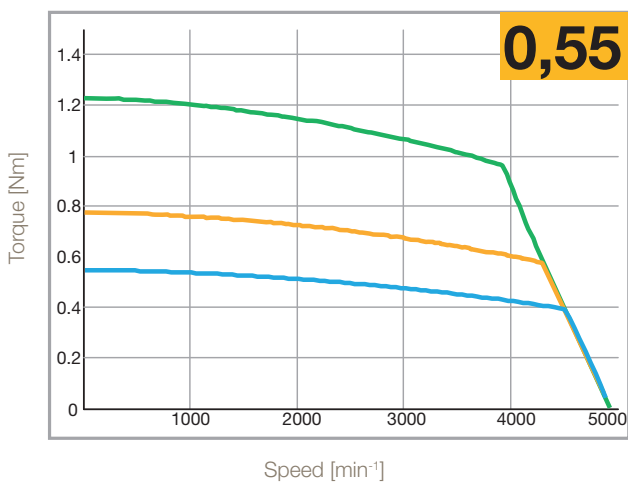

6000 min<sup>-1</sup> 230 V

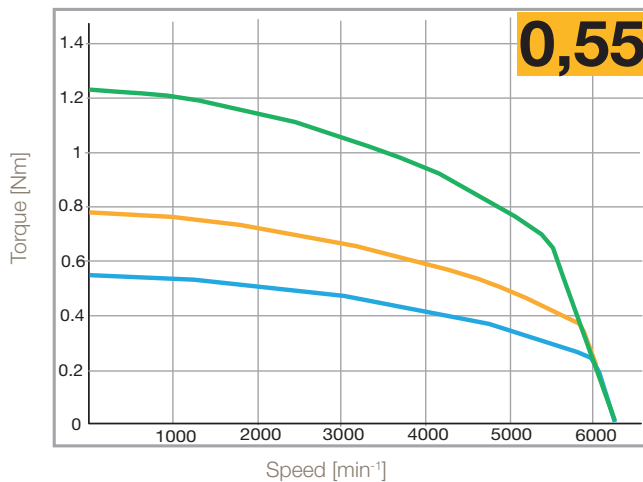

1600 min<sup>-1</sup> 230 V - 3000 min<sup>-1</sup> 400 V

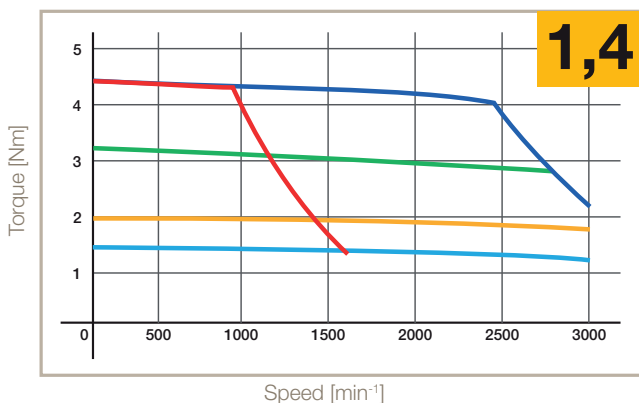

3000 min<sup>-1</sup> 230 V - 6000 min<sup>-1</sup> 400 V

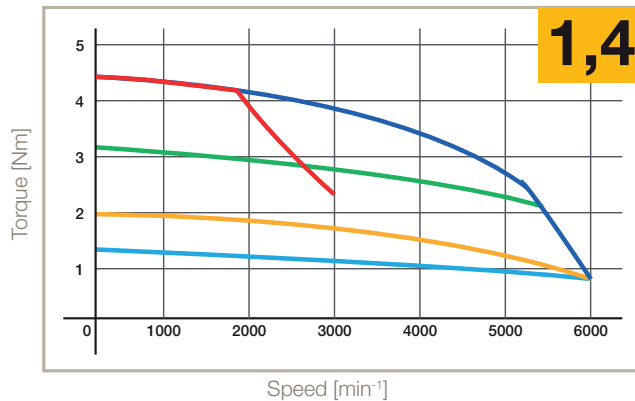

- S1 65 K, ΔT
- S3 10 %, 5 min, 400 V
- S3 50 %, 5 min
- S3 10 %, 5 min, 230 V
- S3 50 %, 5 min
- S3 20 %, 5 min



**SMH/B82**

1600 min<sup>-1</sup> 230 V - 3000 min<sup>-1</sup> 400 V

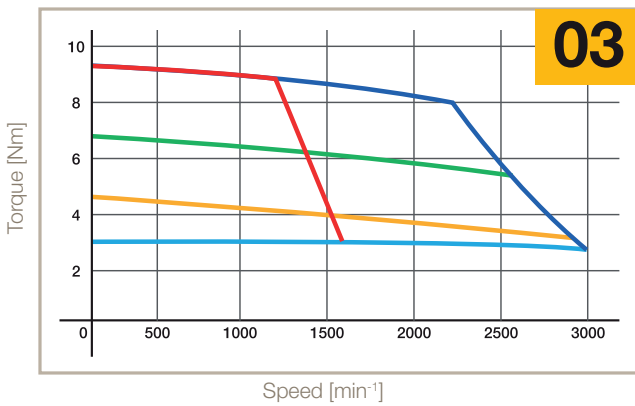

3000 min<sup>-1</sup> 230 V - 5600 min<sup>-1</sup> 400 V

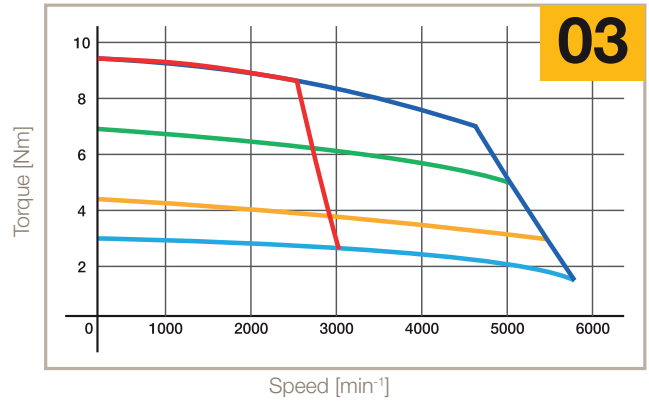

**SMH/B100**

1600 min<sup>-1</sup> 230 V - 3000 min<sup>-1</sup> 400 V

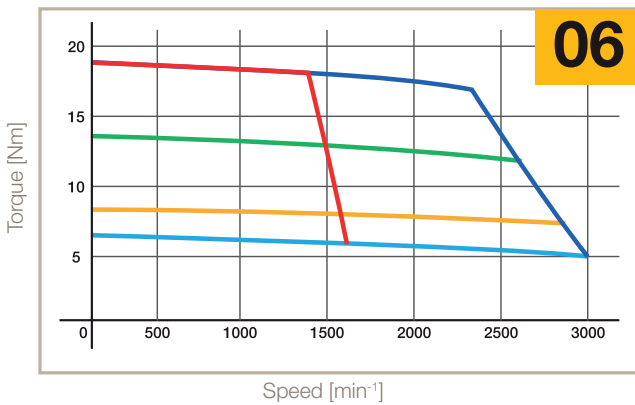

3000 min<sup>-1</sup> 230 V - 5600 min<sup>-1</sup> 400 V

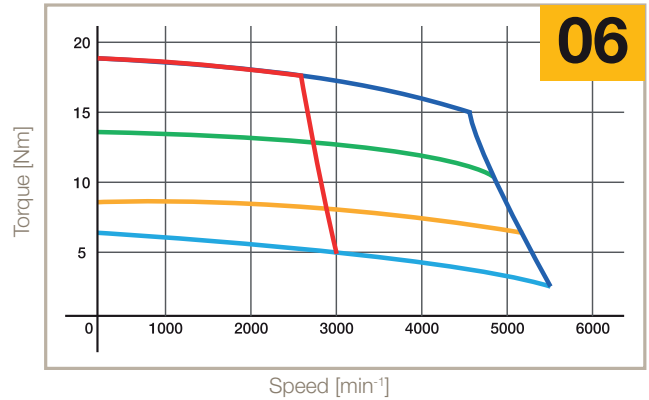

**SMH/B115**

1600 min<sup>-1</sup> 230 V - 3000 min<sup>-1</sup> 400 V

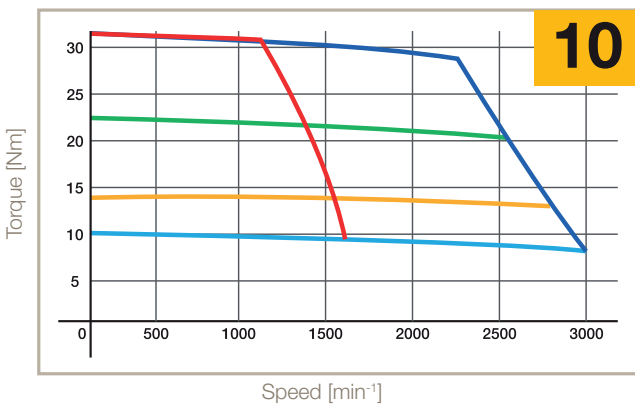

3000 min<sup>-1</sup> 230 V - 5600 min<sup>-1</sup> 400 V

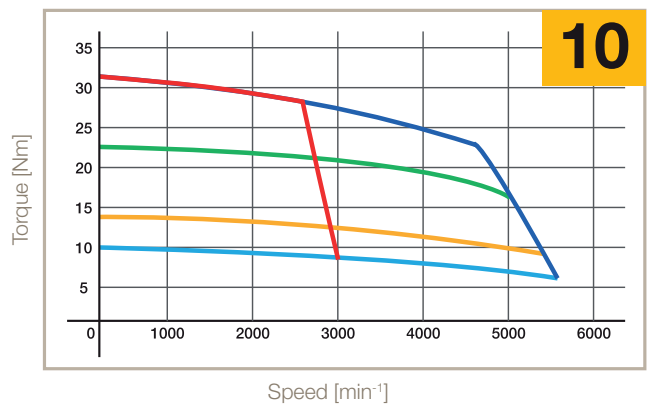

- S1 65 K, ΔT
- S3 10 %, 5 min, 400 V
- S3 50 %, 5 min
- S3 10 %, 5 min, 230 V
- S3 50 %, 5 min
- S3 20 %, 5 min

**SMH/B142**

1800 min<sup>-1</sup> 230 V - 3000 min<sup>-1</sup> 400 V

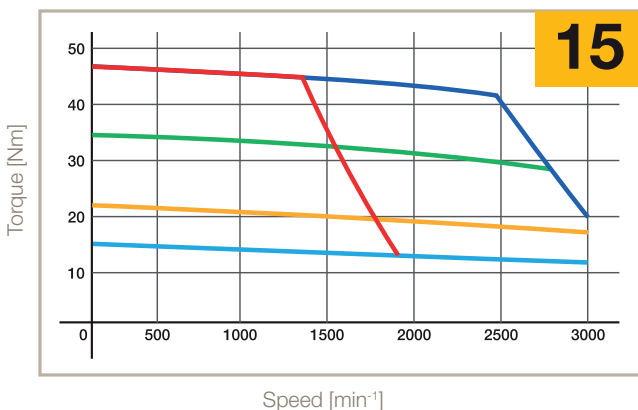

3000 min<sup>-1</sup> 230 V - 5600 min<sup>-1</sup> 400 V

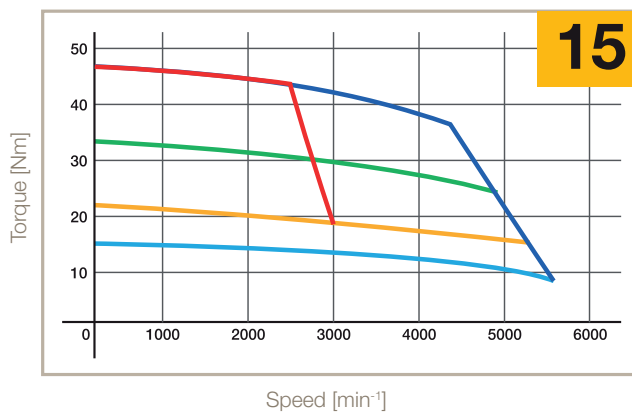

1000 min<sup>-1</sup> 400 V

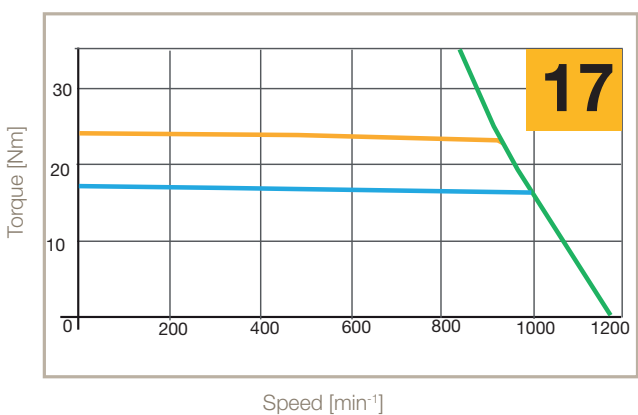

**SMH/B170**

1600 min<sup>-1</sup> 230 V - 3000 min<sup>-1</sup> 400 V

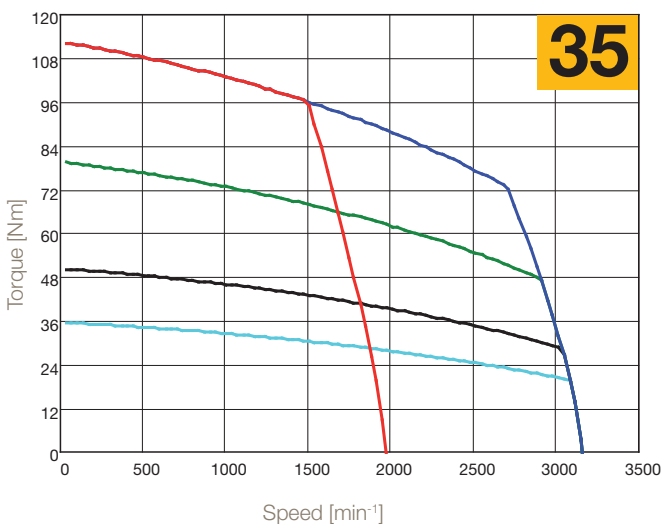

2000 min<sup>-1</sup> 400 V

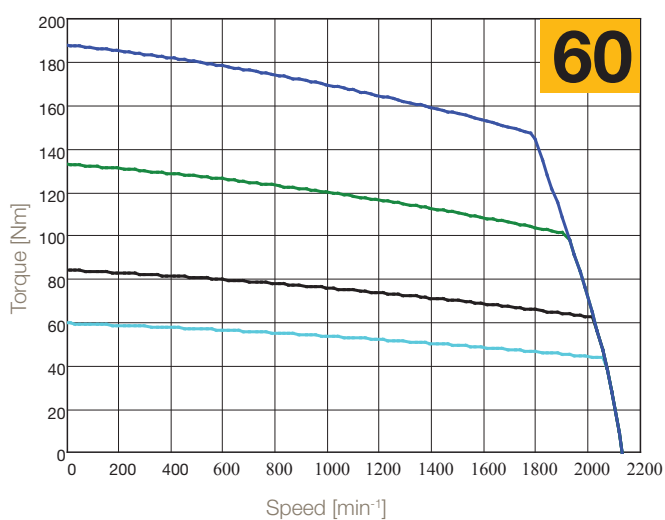

- S1 65 K, ΔT
- S3 10 %, 5 min, 230 V
- S3 50 %, 5 min
- S3 20 %, 5 min

### Dimensions of Standard Motors with Resolver Feedback

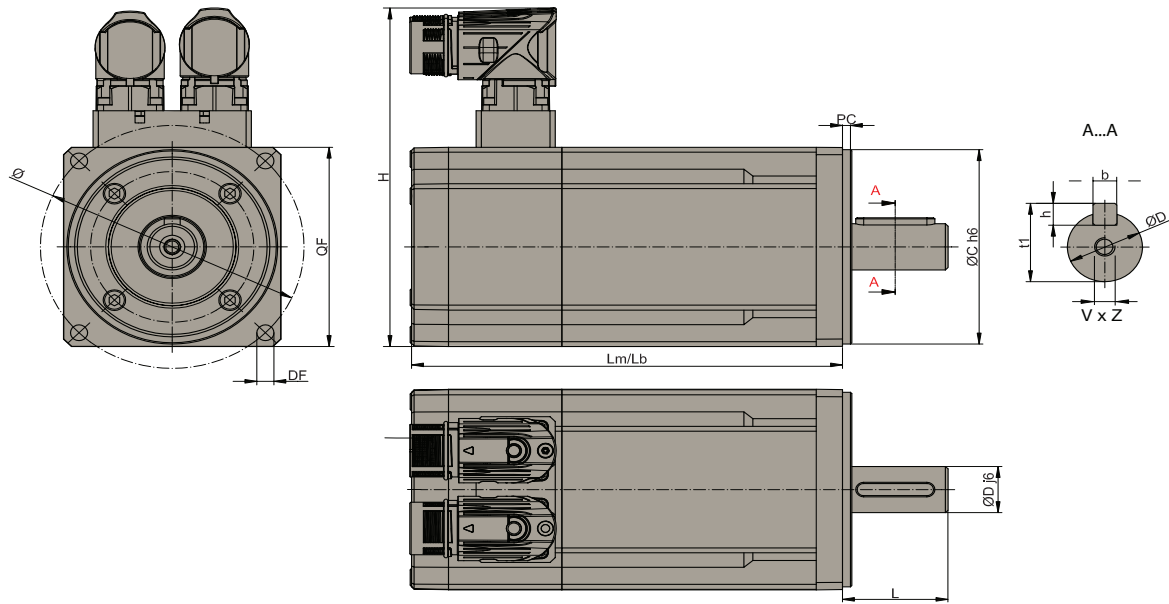

Dimensions [mm]

Motors Size		LM	LB	Weight [kg]	DxL	bxh	t1	VxZ	H	C	Ø	DF	PC	QF	Order Code QF
SMH / B	40	0,19	87.5 119.5	0.53 n.a.	8x20	3x3	9.2	n.a.	60 Layout 2Y	30	50	4.3	2.5	40	5
		0,38	105.5 137.5	0.68 n.a.	8x20	3x3	9.2	n.a.	60 Layout 2Y	30	50	4.3	2.5	40	5
	60	0,55	91.2 137	1 1.3	9x20 11x23	3x3 4x4	10.2 12.5	- M4x10	118 Layout 2I	40	63	5.5	2.5	60	8
			60	75	6	2.5	70	5							
		1,4	129.5 161	1.5 1.8	9x20 11x23	3x3 4x4	10.2 12.5	- M4x10		40	63	5.5	2.5	60	8
			60	75	6	2.5	70	5							
	82	03	159 202	3.6 4.3	11x23 <sup>(2)</sup> 14x30	4x4 5x5	12.5 16	M4x10 M5x12.5	140 Layout 2I	60	75	6	2.5	70	7
			163.5 206.5	3.6 4.3	11x23 <sup>(2)</sup> 14x30 19x40 <sup>(1)</sup>	4x4 5x5 6x6	12.5 16 21.5	M4x10 M5x12.5 M6x16		80	100	6.5	3.5	82	8
			95	115	9	3.5	100	5							
	100	06	191.5 238.5	4.7 5.3	19x40 24x50	6x6 8x7	21.5 27	M6x16 M8x19	157.5 Layout 2I	80	100	7	3.5	100	8
			95	115	9	3.5	100	5							
	115	10	220 265	7.7 9.7	19x40 24x50 28x60	6x6 8x7 8x7	21.5 27 31	M6x16 M8x19 M10x22	157.5 Layout 2I	95	115	9	3.5	115	9
										95	130	9	3.5	115	8
										110	130	9	3.5	130	7
										130	165	11	3.5	145	5
	142	15	243 293	13 16	19x40 24x50 28x60	6x6 8x7 8x7	21.5 27 31	M6x16 M8x19 M10x22	185 Layout 2I	130	165	11	3.5	142	5
170	35	306	30	38x80	10x8	41	M12x32	212.3 Layout 2I	180	215	14	4	205	5	
	60	409	50	38x80	10x8	41	M12x32	212.3 Layout 2I	180	215	14	4	205	5	

- LM:** Motor's length without brake and with resolver
- LB:** Motor's length with brake and resolver
- DxL:** Shaft diameter x shaft length
- bxh:** Key dimension
- t1:** Overall shaft height
- VxZ:** Shaft hole depth
- C:** Centering

- H:** Height
- DF:** Fixing holes
- Ø:** Interaxis hole
- QF:** Mounting flange
- PC:** Centre Depth

<sup>1)</sup> not available with flange 7  
<sup>2)</sup> only for torque <2 Nm

## Options

Parker SMH / SMB family motors are available with standard and custom options to adapt motor on your application. If the option for your application is not listed, please consult our technical department.

### Holding Brake

All SMH / SMB motors are available with option holding brake.

The fail-safe (supply voltage 24 VDC  $\pm 10\%$ ) holding brake is incorporated in the motor at the opposite side of the front flange (SM\_170 front side) and is applied when there is no voltage present. Because of the power loss caused by the brake, torque values must be reduced by 5 %. The holding brakes shall be used with the motor at a standstill and not for dynamic braking. For normal uses, they are maintenance free brakes.

Motor	Voltage [V]	Current [A]	Torque @20 °C [Nm]	Added Length with resolver [mm]	Added Weight [kg]	Added Inertia [kgmm <sup>2</sup> ]
SMH / SMB40	24	0.25	0.4	32	0.15	-
SMH / SMB60		0.34	2.2	31.5	0.3	12.5
SMH / SMB82		0.5	4.5	43	0.7	43
SMH / SMB100		0.67	9	47	0.6	104
SMH / SMB115		0.67	9	45	2	100
SMH / SMB142		0.75	22	50	3	200
SMH / SMB170		1.67	72	-	2.9	1600

### Medium Inertia

Where the application needs different values of inertia, SMH / SMB can provide a standard adder.

Motor	Added inertia [kgmm <sup>2</sup> ]	Added length with resolver [mm]	Added weight [kg]
SMH / SMB60	29	31.5	0.32
SMH / SMB82	270	43	0.91
SMH / SMB100	284	47	0.68
SMH / SMB115	900	45	2.28
SMH / SMB142	690	50	2.49
SMH / SMB170	consult Parker	consult Parker	consult Parker

### Feedback

Motors may be equipped with various feedback types in order to meet the different requirements for precision, signal that the application needs. The standard motor includes the resolver feedback. Hiperface Encoder, DSL Encoder, EnDat Encoder, Incremental Encoder are available like the following tables.

#### Resolver

Poles	2
Transformation ratio	0.5
Operating temperature	-50...+150 °C
SM_ associations	All Sizes

#### Incremental Encoder with Hall Sensor

Code	A1	A2	A3	B3	C4	D3
Resolution [C/T]	2000	2048	4096	2048	5000	5000
Poles	8					
System accuracy	$\pm 32''$	$\pm 32''$	$\pm 16''$	$\pm 32''$	$\pm 13''$	$\pm 13''$
Voltage	+5 VDC $\pm 5\%$ - 200 mA					
Reference mark	Yes					
Max speed [min <sup>-1</sup> ]	6000					
Output circuit	Line drive differential mode 20 mA					
Operating temperature	-20 °C...+100 °C	-20 °C...+85 °C	-20 °C...+100 °C	-20 °C...+85 °C	-20 °C...+100 °C	-20 °C...+85 °C
SM_ motors associations						
SM_40	N	N	N	N	N	N
SM_60	N	N	N	Y (+17 mm length)	N	Y (+17 mm length)
SM_82	Y	Y	Y	N	Y	N
SM_100	Y	Y	Y	N	Y	N
SM_115	Y	Y	Y	N	Y	N
SM_142	Y	Y	Y	N	Y	N
SM_170	Y	Y	Y	N	Y	N

### Hiperface Absolute Encoder

Code	S1	S2	S3	S4	S5	S6
Type	Optical					
Turn	Single	Multi	Single	Multi	Single	Multi
Incremental signals	1 V <sub>PP</sub>				-	-
Line count	1024		128		-	-
Resolution	32768 (15 bit)		4096 (12 bit)		262144 (18 bits)	
Absolute rotation	1	4096	1	4096	1	4096
System accuracy	±45"		±320"		±40"	
Power supply	8 VDC				7...12 VDC	
Max speed [min <sup>-1</sup> ]	6000		12000	9000		
Temperature	-20 °C...+115 °C		-20 °C...+110 °C		20 °C...+105 °C	
Safety integrity level	SIL2 (IEC 61508), SILCL2 (IEC 62061)				SIL2 (IEC 61508), SILCL2 (IEC 62061)	
<b>SM_ motors associations</b>						
SM_40	N	N	N	N	N	N
SM_60	N		Y (+17 mm length without brake) (+30 mm length with brake)		Y (+17 mm length without brake) (+30 mm length with brake)	
SM_82	Y (+17 mm length without brake) (+30 mm length with brake)		Y	Y	Y	Y
SM_100	Y (+20 mm length)				Y (+20 mm length)	
SM_115	Y	Y	Y	Y	Y	Y
SM_142	Y	Y	Y	Y	Y	Y
SM_170	Y	Y	Y	Y	Y	Y

Code	A6	A7	C6	C7
Type	Optical			
Turn	Single	Multi	Single	Multi
Incremental signals	1 V <sub>PP</sub>			
Line count	1024		128	
Resolution	32768 (15 bit)		4096 (12 bit)	
Absolute rotation	1	4096	1	4096
System accuracy	±45"		±320"	
Power supply	8 VDC			
Max speed [min <sup>-1</sup> ]	6000		12000	9000
Temperature	-20 °C...+115 °C		-20 °C...+110 °C	
Safety integrity level	Not Available		Not Available	
<b>SM_ motors associations</b>				
SM_40	N	N	N	N
SM_60	N		Y (+17 mm length without brake) (+30 mm length with brake)	
SM_82	Y (+17 mm length without brake) (+30 mm length with brake)		Y	Y
SM_100	Y (+20 mm length)			
SM_115	Y	Y	Y	Y
SM_142	Y	Y	Y	Y
SM_170	Y	Y	Y	Y

### EnDat Absolute Encoder

Code	B9	D5	F2	F4
Type	Inductive	Optical		Inductive
Turn	Multi			
Incremental signals	1 V <sub>PP</sub>			
Line count	32	512		16
Positions per revolutions	131 072 (17 bit)	8192 (13 bit)		262 144 (18 bit)
Distinguishable revolutions	4096	4096		
System accuracy	±400"	±60"		±480"
Power supply	5 VDC			
Max speed [min <sup>-1</sup> ]	12 000	7 000	12 000	
Temperature	-20 °C...+115 °C	-30 °C...+115 °C	-40 °C...+115 °C	-20 °C...+115 °C
Absolute position values	EnDat 2.1	EnDat 2.2		EnDat 2.1
Safety integrity level	Not Available			
<b>SM_ motors associations</b>				
SM_40	N	N	N	N
SM_60	N	N	Y (+17 mm length without brake) (+9 mm length with brake)	
SM_82	Y (+22.5 mm length without brake) (+18 mm length with brake)		N	N
SM_100	Y (+20 mm length)		N	N
SM_115	Y	Y	N	N
SM_142	Y	Y	N	N
SM_170	Y	Y	N	N

### Servofan kit

Designed for the SMH/SMB servo motors family, the new Servofan kit allows extra performances over and above the specified motor torque rating. Brushless servo motors are meant for high dynamic applications and where the functionality is un-constant (S3 Cycle). In this conditions the new Servofan kit increases by 25% the motor torque and it also permits the use in continuous duty (S1) improving the performances. Suitable for 100-115, 142 and 170mm frames sizes within the SMB/SMH ranges, the kit is available with an IP20 rating and is ideal for deployment in applications within food/ packaging, hydraulic servo pump application, material forming, factory automation and material handling sectors. For customers who already have motors in the specified frame sizes and would like more torque the new Servofan kit can be purchased separately and added.

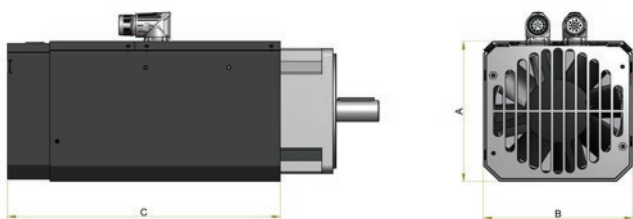

### Dimensions

Model	A	B	C
SF-1000-00	131,7	128	271
SF-1420-00	162	159	296
SF-1701-00	184	186	365
SF-1702-00			465

### Order code

	1	2	3	4		
Order example	SF	-	100	00	-	00

#### 1 Servofan kit

SF Servofan kit

#### 2 SMH-SMB motor size

100 For SMH-SMB size 100 or 115  
142 For SMH-SMB size 142  
170 For SMH-SMB size 170

#### 3 Motor length

0 Standard for all size except size 170  
1 Only for 170 size - Length 1 - 35Nm  
2 Only for 170 size - Length 2 - 60Nm

#### 4 Special execution

00 Standard version  
01 Special version without connectors

## Layout and Connectors

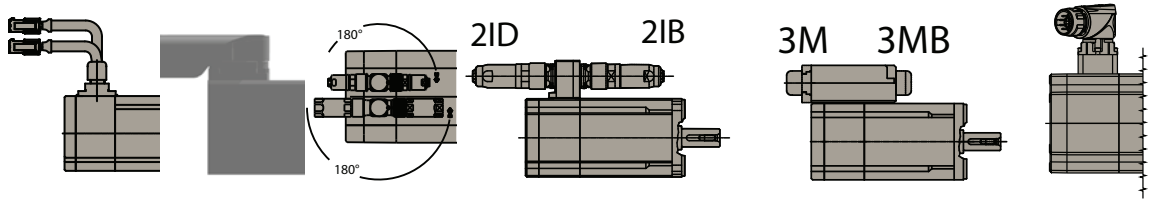

	200 mm Flying leads with molex plugs 0V	Y-Tech rotatable connector 2Y	2x Parallel upright connectors 2I	2x Forward facing connectors 2IB	2x Rear facing connectors 2ID	Terminal box rear facing 3M	Terminal box forward facing 3MB	Hiperface DSL® Connector (IZ)
SMH_40	N	Y	N	N	N	N	N	N
SMH_60	Y	Y	Y	Y	N	N	N	Y
SMH_82	N	N	Y	Y	N	N	N	Y
SMH_100	N	N	Y	Y	N	N	N	Y
SMH_115	N	N	Y	Y	N	N	N	Y
SMH_142	N	N	Y	Y	N	N	N	Y
SMH_170	N	N	Y	N	N	N	N	Y
SMB_40	N	Y	N	N	N	N	N	N
SMB_60	Y	Y	Y	Y	Y	Y	Y	N
SMB_82	N	N	Y	Y	Y	Y	Y	N
SMB_100	N	N	Y	Y	Y	Y	Y	N
SMB_115	N	N	Y	Y	Y	Y	Y	N
SMB_142	N	N	Y	Y	Y	Y	Y	N
SMB_170	N	N	Y	N	N	N	N	N
SME_60	N	Y	N	Y	Y	N	N	Y
SME_82	N	N	N	Y	Y	N	N	Y
SME_100	N	N	N	Y	Y	N	N	Y
SME_115	N	N	Y	N	N	N	N	Y
SME_142	N	N	Y	N	N	N	N	Y
SME_170	N	N	Y	N	N	N	N	Y

### Power connector (0V)

6	5	4
3	2	1

Pin	Description
1	GND - shield
2	Brake 0 VDC
3	Brake +24 VDC
4	W
5	V
6	U

#### Part number

**CONMOT6M** Female Connector

### Resolver connector (0V)

12	11	10	9	8	7
6	5	4	3	2	1

Pin	Description
1	n.c.
2	n.c.
3	n.c.
4	PTC
5	PTC
6	GND - shield
7	SIN +
8	SIN -
9	COS +
10	COS -
11	EXTC -
12	EXTC +

#### Part number

**CONRES12M** Female Connector

### Hiperface connector (0V)

12	11	10	9	8	7
6	5	4	3	2	1

Pin	Description
1	SIN +
2	SIN -
3	RS485 +
4	0 V
5	PTC
6	PTC
7	VDC +
8	COS +
9	COS -
10	RS485 -
11	GND - shield
12	n.c.

#### Part number

**CONRES12M** Female Connector

**Power connector (2I, 2IB, 2ID)**

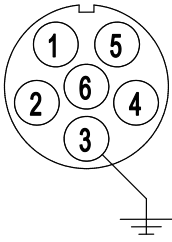

Pin	Description
1	U
2	V
3	GND - shield
4	Brake +24 VDC
5	Brake 0 VDC
6	W

Part number	
<b>CONMOT82F</b>	Female Connector

**Incremental encoder connector (2I, 2IB, 2ID)**

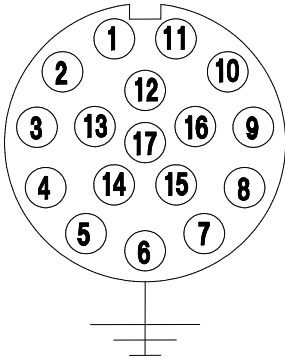

Pin	Description	
1	5 V	
2	0 V	
3	A +	
4	A -	
5	B +	
6	B -	
7	Z +	
8	PTC	KTY -
6	PTC	KTY +
10	Z -	
11	Hall A +	
12	Hall A -	
13	Hall B +	
14	Hall B -	
15	Hall C +	
16	Hall C -	
17	n.c.	

Part number	
<b>CONENCF</b>	Female Connector

**Resolver connector (2I, 2IB, 2ID)**

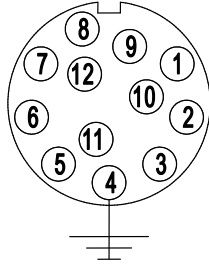

Pin	Description	
1	SIN -	
2	SIN +	
3	n.c.	
4	GND - shield	
5	n.c.	
6	n.c.	
7	EXCT -	
8	PTC	KTY -
9	PTC	KTY +
10	EXCT +	
11	COS +	
12	COS -	

Part number	
<b>CONRES82F</b>	Female Connector

**Absolute encoder SINCOS - EnDat (2I, 2IB, 2ID)**

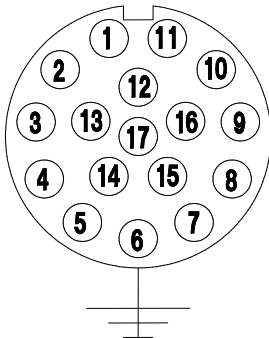

Pin	Description	
1	UP Sensor	
2	n.c.	
3	n.c.	
4	0 V Sensor	
5	PTC	KTY -
6	PTC	KTY +
7	UP	
8	CK +	
9	CK -	
10	0 V	
11	GND - shield	
12	B +	
13	B -	
14	Data +	
15	A +	
16	A -	
17	Data -	

Part number	
<b>CONENCF</b>	Female Connector

**Absolute encoder SINCOS - Hiperface (2I, 2IB, 2ID)**

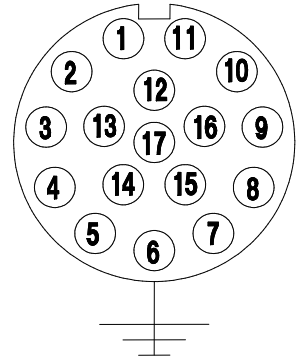

Pin	Description	
1	SIN +	
2	SIN -	
3	RS485 +	
4	n.c.	
5	n.c.	
6	n.c.	
7	GND - shield	
8	PTC	KTY -
9	PTC	KTY +
10	+ VDC	
11	COS +	
12	COS -	
13	RS485 -	
14	n.c.	
15	n.c.	
16	n.c.	
17	n.c.	

Part number	
<b>CONRES82F</b>	Female Connector

**Hiperface DSL® Connector (IZ)**

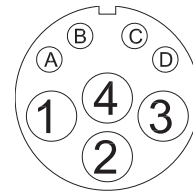

Pin	Description
1	U
2	GND
3	V
4	W
A	Brake +
B	Brake -
C	Signal +
D	Signal -

Part number	
<b>CONMOT2IZF</b>	Female Connector



## Associated Drives

Motor	Rated Speed [min <sup>-1</sup> ]	Stall Current [A]	PSD1S	PSD1M
<b>230 VAC supply voltage</b>				
SM_40_60_0,19	6000	0.78	PSD1S_1200	PSD1M_1222
SM_40_60_0,38	6000	1.2	PSD1S_1200	PSD1M_1222
SM_60_30_0,55	3000	0.7	PSD1S_1200	PSD1M_1222
SM_60_45_0,55	4500	1	PSD1S_1200	PSD1M_1222
SM_60_60_0,55	6000	1.4	PSD1S_1200	PSD1M_1222
SM_60_16_1,4	1600	0.95	PSD1S_1200	PSD1M_1222
SM_60_30_1,4	3000	1.73	PSD1S_1200	PSD1M_1222
SM_60_45_1,4	4500	2.37	PSD1S_1300	PSD1M_1433
SM_60_60_1,4	6000	2.98	PSD1S_1300	PSD1M_1433
SM_60_75_1,4	7500	3.85	PSD1S_1300	PSD1M_1433
SM_82_10_03	1000	1.2	PSD1S_1200	PSD1M_1222
SM_82_16_03	1600	1.8	PSD1S_1200	PSD1M_1222
SM_82_30_03	3000	3.1	PSD1S_1300	PSD1M_1433
SM_82_33_03	3300	3.5	PSD1S_1300	PSD1M_1433
SM_82_45_03	4500	4.7	PSD1S_1300	PSD1M_1433
SM_82_60_03	6000	6.1	n.a.	PSD1M_1433
SM_82_75_03	7500	7.5	n.a.	PSD1M_1433
SM_100_16_06	1600	3.7	PSD1S_1300	PSD1M_1433
SM_100_30_06	3000	5.9	n.a.	PSD1M_1433
SM_100_45_06	4500	9.4	n.a.	PSD1M_1630
SM_100_55_06	5500	11.8	n.a.	PSD1M_1630
SM_100_75_06	7500	14.7	n.a.	PSD1M_1630
SM_115_16_10	1600	6	n.a.	PSD1M_1433
SM_115_30_10	3000	10.5	n.a.	PSD1M_1630
SM_115_40_10	4000	14.7	n.a.	PSD1M_1630
SM_115_54_10	5400	18.2	n.a.	PSD1M_1800
SM_142_18_15	1800	9.7	n.a.	PSD1M_1630
SM_142_30_15	3000	16	n.a.	PSD1M_1800
SM_170_11_35	1100	13.3	n.a.	PSD1M_1630
SM_170_16_35	1600	20	n.a.	PSD1M_1800
SM_170_25_35	2500	29	n.a.	PSD1M_1800

<b>400 VAC supply voltage</b>				
SM_60_30_1,4	3000	0.95	n.a.	PSD1M_1222
SM_60_45_1,4	4500	1.37	n.a.	PSD1M_1222
SM_60_60_1,4	6000	1.73	n.a.	PSD1M_1222
SM_60_75_1,4	7500	2.15	n.a.	PSD1M_1433
SM_82_30_03	3000	1.8	n.a.	PSD1M_1222
SM_82_45_03	4500	2.7	n.a.	PSD1M_1433
SM_82_56_03	5600	3.1	n.a.	PSD1M_1433
SM_82_60_03	6000	3.5	n.a.	PSD1M_1433
SM_82_75_03	7500	4.4	n.a.	PSD1M_1433
SM_100_30_06	3000	3.7	n.a.	PSD1M_1433
SM_100_45_06	4500	5.6	n.a.	PSD1M_1433
SM_100_56_06	5600	5.9	n.a.	PSD1M_1433
SM_100_75_06	7500	9.4	n.a.	PSD1M_1630
SM_115_20_10	2000	4.5	n.a.	PSD1M_1433
SM_115_30_10	3000	6.0	n.a.	PSD1M_1433
SM_115_40_10	4000	8.0	n.a.	PSD1M_1433
SM_115_56_10	5600	10.5	n.a.	PSD1M_1630
SM_142_20_15	2000	6.4	n.a.	PSD1M_1433
SM_142_30_15	3000	9.7	n.a.	PSD1M_1630
SM_142_45_15	4500	14.4	n.a.	PSD1M_1630
SM_142_56_15	5600	16	n.a.	PSD1M_1800
SM_170_10_35	1000	6.8	n.a.	PSD1M_1630
SM_170_20_35	2000	13.3	n.a.	PSD1M_1630
SM_170_27_35	2700	18	n.a.	PSD1M_1800
SM_170_30_35	3000	20	n.a.	PSD1M_1800
SM_170_10_60	1000	11.7	n.a.	PSD1M_1630
SM_170_20_60	2000	22.6	n.a.	PSD1M_1800
SM_170_30_60	3000	35.7	n.a.	n.a.

# Order Code

## Serie SMH / SMB / SME

	1	2	3	4	5	6	7	8	9	10	11	12	13	14	
Order example	SMH	A	60	30	1,4	5	9			2I		64	A6	M	2

<b>1 Type Of Motor (mandatory field)</b>	<b>SMH</b>	Motor with Resolver for PSD/C3
	<b>SMB</b>	Motor with Resolver for TPDM/SLVDN
	<b>SME</b>	Motor with Encoder for TPDM/SLVDN
<b>2 Brake Option</b>	<b>empty field</b>	No Brake Option
	<b>A</b>	Motor with Holding Brake
<b>3 Motor Frame Size (mandatory field)</b>	<b>40</b>	Torque range 0.19 Nm or 0.35 Nm
	<b>60</b>	Torque range 0.55 or 1.4 Nm
	<b>82</b>	Torque range 3 Nm
	<b>100</b>	Torque range 6 Nm
	<b>115</b>	Torque range 10 Nm
	<b>142</b>	Torque range 15 or 17 Nm
	<b>170</b>	Torque range 35 or 60 Nm
<b>4 Winding (mandatory field)</b>	<b>nn</b>	min <sup>-1</sup> (x100) see "Technical Data" (page 6)
<b>5 Motor Torque (mandatory field)</b>	<b>nn</b>	Torque [Nm] see "Technical Data" (page 6)
<b>6 Flange (mandatory field)</b>	<b>5</b>	All sizes
	<b>7</b>	Only for Size 82 and 115
	<b>8</b>	Only for Size 60, 82, 100 and 115
	<b>9</b>	Only for Size 115
<b>7 Shaft (mandatory field)</b>	<b>8</b>	8x20 mm for size 40
	<b>9</b>	9x20 mm for size 60
	<b>11</b>	11x23 mm for size 60
	<b>14</b>	14x30 mm for size 82
	<b>19</b>	19x40 mm for size 82/100/115/142
	<b>24</b>	24x50 mm for size 100/115/142
	<b>28</b>	28x60 mm for size 115/142
	<b>38</b>	38x80 mm for size 170
<b>8 Key Shaft option</b>	<b>Empty field</b>	Shaft with Key
	<b>S</b>	Shaft without key
<b>9 Layout - Connectors (mandatory field)</b>	<b>0V</b>	Cable exit and Molex Flying connectors - 200 mm above
	<b>2I</b>	Rotatable Interconnectron receptacles
	<b>2IB</b>	90° Interconnectron receptacles - forward facing
	<b>2ID</b>	90° Interconnectron receptacles - rear facing
	<b>3M</b>	Terminal box rear facing
	<b>3MB</b>	Terminal box forward facing
	<b>2Y</b>	Y-Tech connectors
	<b>IZ</b>	DSL® connectore (not for size 40)
<b>10 Female connectors option (only for SMB/SME)</b>	<b>Empty field</b>	With Female / flying connectors
	<b>W</b>	Without Female / flying connectors
<b>11 Protection Degree (mandatory field)</b>	<b>64</b>	IP64
	<b>65</b>	IP65 (standard for SMB170)
<b>12 Feedback</b>	<b>Empty field</b>	Standard Resolver
	<b>A1</b>	Encoder 2000 ppr + Hall - TAMAGAWA OIH48
	<b>A2</b>	Encoder 2048 ppr + Hall - TAMAGAWA OIH48
	<b>A3</b>	Encoder 4096 ppr + Hall - TAMAGAWA OIH48
	<b>A6</b>	SinCos Hiperface Encoder Single-Turn - STEGMANN SRS50/52
	<b>A7</b>	SinCos Hiperface Encoder Multi-Turn - STEGMANN SRS50/52
	<b>B3</b>	Encoder 2048 ppr + Hall - TAMAGAWA OIH35
	<b>B9</b>	SinCos EnDat Encoder Multi-Turn - HEIDENHAIN EQI1331
	<b>C4</b>	Encoder 5000 ppr + Hall - TAMAGAWA OIH48
	<b>C6</b>	SinCos Hiperface Encoder Single-Turn - STEGMANN SKS36
	<b>C7</b>	SinCos Hiperface Encoder Multi-Turn - STEGMANN SKM36
	<b>D3</b>	Encoder 5000ppr + Hall - TAMAGAWA OIH35
	<b>D5</b>	SinCos EnDat Encoder Multi-Turn - HEIDENHAIN EQN1325
	<b>F2</b>	SinCos EnDat Encoder Multi-Turn - HEIDENHAIN EQN1125
	<b>F4</b>	SinCos EnDat Encoder Multi-Turn - HEIDENHAIN EQI1130
	<b>S1</b>	SinCos Hiperface Encoder Single-Turn - STEGMANN SRS50S, SIL2
	<b>S2</b>	SinCos Hiperface Encoder Multi-Turn - STEGMANN SRS50S, SIL2
	<b>S3</b>	SinCos Hiperface Encoder Single-Turn - STEGMANN SKS36S, SIL2
	<b>S4</b>	SinCos Hiperface Encoder Multi-Turn - STEGMANN SKM36S, SIL2
	<b>S5</b>	Hiperface DSL® Encoder Feedback SIL2 32768 steps/rev Single Turn
	<b>S6</b>	Hiperface DSL® Encoder Feedback SIL2 32768 steps/rev x 4096 Multi Turn

**13 Option Inertia**

**Empty field** Standard Inertia

**M** Medium Inertia

**14 Voltage**

**0** 80 V

**2** 220-230 V (Standard)

**4** 380-400 V (Standard)

## Order Code

### Motor Power Cable for SMH / SMB Motors

	1	2	3	4		5		6		7		8
Order example	<b>CBM</b>	<b>005</b>	<b>H</b>	<b>D</b>	-	<b>M15</b>	-	<b>PSX</b>	-	<b>0010</b>	-	<b>00</b>

<b>1</b>	<b>Power Cable Drive</b>	
	<b>CBM</b>	Power cable drive
<b>2</b>	<b>Section [mm<sup>2</sup>]</b>	
	<b>005</b>	0.5 mm <sup>2</sup>
	<b>007</b>	0.7 mm <sup>2</sup>
	<b>010</b>	1 mm <sup>2</sup>
	<b>015</b>	1.5 mm <sup>2</sup>
	<b>025</b>	2.5 mm <sup>2</sup>
<b>3</b>	<b>Cable</b>	
	<b>S</b>	Standard
	<b>H</b>	High Flex
<b>4</b>	<b>Brake</b>	
	<b>0</b>	Power cable standard - without brake
	<b>B</b>	Power cable standard - with brake
	<b>D</b>	DSL® Power cable with brake
<b>5</b>	<b>Motor Connector</b>	
	<b>M15</b>	M15 Interconnectron connector
	<b>M23</b>	M23 Interconnectron connector
	<b>M40</b>	M40 Interconnectron connector
<b>6</b>	<b>Drive</b>	
	<b>PSX</b>	Parker PSD1-S
	<b>PMX</b>	Parker PSD1-M
	<b>SDX</b>	Parker Servonet DC
<b>7</b>	<b>Length</b>	
	<b>0000</b>	Cable length 4 digits (example 50 m = 0500)*
<b>8</b>	<b>Special Execution</b>	
	<b>00</b>	Standard

\* Available length in meter: 1; 2.5; 5; 7.5; 10; 15; 20; 25; 30; 35; 40; 45; 50

## Motor Feedback Cable for SMH / SMB Motors

	1	2	3	4		5		6		7		8
Order example	<b>CBF</b>	<b>RE0</b>	<b>H</b>	<b>0</b>	-	<b>M15</b>	-	<b>PSX</b>	-	<b>0010</b>	-	<b>00</b>

<b>1</b>	<b>Power Cable Drive</b>	
	<b>CBF</b>	Feedback cable drive
<b>2</b>	<b>Feedback</b>	
	<b>RE0</b>	Resolver
<b>3</b>	<b>Cable</b>	
	<b>H</b>	High Flex
<b>4</b>	<b>Brake</b>	
	<b>0</b>	Power cable standard - without brake
<b>5</b>	<b>Motor Connector</b>	
	<b>M15</b>	M15 Interconnectron connector
	<b>M23</b>	M23 Interconnectron connector
	<b>M40</b>	M40 Interconnectron connector
<b>6</b>	<b>Drive</b>	
	<b>PSX</b>	Parker PSD1-S
	<b>PMX</b>	Parker PSD1-M
	<b>SDX</b>	Parker Servonet DC
<b>7</b>	<b>Length</b>	
	<b>0000</b>	Cable length 4 digits (example 50 m = 0500)*
<b>8</b>	<b>Special Execution</b>	
	<b>00</b>	Standard

\* Available length in meter: 1; 2.5; 5; 7.5; 10; 15; 20; 25; 30; 35; 40; 45; 50





# Parker's Motion & Control Technologies

At Parker, we're guided by a relentless drive to help our customers become more productive and achieve higher levels of profitability by engineering the best systems for their requirements. It means looking at customer applications from many angles to find new ways to create value. Whatever the motion and control technology need, Parker has the experience, breadth of product and global reach to consistently deliver. No company knows more about motion and control technology than Parker. For further info call 00800 27 27 5374



## Aerospace

### Key Markets

Aftermarket services  
Commercial transports  
Engines  
General & business aviation  
Helicopters  
Launch vehicles  
Military aircraft  
Missiles  
Power generation  
Regional transports  
Unmanned aerial vehicles

### Key Products

Control systems & actuation products  
Engine systems & components  
Fluid conveyance systems & components  
Fluid metering, delivery & atomization devices  
Fuel systems & components  
Fuel tank inerting systems  
Hydraulic systems & components  
Thermal management  
Wheels & brakes



## Climate Control

### Key Markets

Agriculture  
Air conditioning  
Construction Machinery  
Food & beverage  
Industrial machinery  
Life sciences  
Oil & gas  
Precision cooling  
Process  
Refrigeration  
Transportation

### Key Products

Accumulators  
Advanced actuators  
CO<sub>2</sub> controls  
Electronic controllers  
Filter driers  
Hand shut-off valves  
Heat exchangers  
Hose & fittings  
Pressure regulating valves  
Refrigerant distributors  
Safety relief valves  
Smart pumps  
Solenoid valves  
Thermostatic expansion valves



## Electromechanical

### Key Markets

Aerospace  
Factory automation  
Life science & medical  
Machine tools  
Packaging machinery  
Paper machinery  
Plastics machinery & converting  
Primary metals  
Semiconductor & electronics  
Textile  
Wire & cable

### Key Products

AC/DC drives & systems  
Electric actuators, gantry robots & slides  
Electrohydraulic actuation systems  
Electromechanical actuation systems  
Human machine interface  
Linear motors  
Stepper motors, servo motors, drives & controls  
Structural extrusions



## Filtration

### Key Markets

Aerospace  
Food & beverage  
Industrial plant & equipment  
Life sciences  
Marine  
Mobile equipment  
Oil & gas  
Power generation & renewable energy  
Process  
Transportation  
Water Purification

### Key Products

Analytical gas generators  
Compressed air filters & dryers  
Engine air, coolant, fuel & oil filtration systems  
Fluid condition monitoring systems  
Hydraulic & lubrication filters  
Hydrogen, nitrogen & zero air generators  
Instrumentation filters  
Membrane & fiber filters  
Microfiltration  
Sterile air filtration  
Water desalination & purification filters & systems



## Fluid & Gas Handling

### Key Markets

Aerial lift  
Agriculture  
Bulk chemical handling  
Construction machinery  
Food & beverage  
Fuel & gas delivery  
Industrial machinery  
Life sciences  
Marine  
Mining  
Mobile  
Oil & gas  
Renewable energy  
Transportation

### Key Products

Check valves  
Connectors for low pressure fluid conveyance  
Deep sea umbilicals  
Diagnostic equipment  
Hose couplings  
Industrial hose  
Mooring systems & power cables  
PTFE hose & tubing  
Quick couplings  
Rubber & thermoplastic hose  
Tube fittings & adapters  
Tubing & plastic fittings



## Hydraulics

### Key Markets

Aerial lift  
Agriculture  
Alternative energy  
Construction machinery  
Forestry  
Industrial machinery  
Machine tools  
Marine  
Material handling  
Mining  
Oil & gas  
Power generation  
Refuse vehicles  
Renewable energy  
Truck hydraulics  
Turf equipment

### Key Products

Accumulators  
Cartridge valves  
Electrohydraulic actuators  
Human machine interfaces  
Hybrid drives  
Hydraulic cylinders  
Hydraulic motors & pumps  
Hydraulic systems  
Hydraulic valves & controls  
Hydrostatic steering  
Integrated hydraulic circuits  
Power take-offs  
Power units  
Rotary actuators  
Sensors



## Pneumatics

### Key Markets

Aerospace  
Conveyor & material handling  
Factory automation  
Life science & medical  
Machine tools  
Packaging machinery  
Transportation & automotive

### Key Products

Air preparation  
Brass fittings & valves  
Manifolds  
Pneumatic accessories  
Pneumatic actuators & grippers  
Pneumatic valves & controls  
Quick disconnects  
Rotary actuators  
Rubber & thermoplastic hose & couplings  
Structural extrusions  
Thermoplastic tubing & fittings  
Vacuum generators, cups & sensors



## Process Control

### Key Markets

Alternative fuels  
Biopharmaceuticals  
Chemical & refining  
Food & beverage  
Marine & shipbuilding  
Medical & dental  
Microelectronics  
Nuclear Power  
Offshore oil exploration  
Oil & gas  
Pharmaceuticals  
Power generation  
Pulp & paper  
Steel  
Water/wastewater

### Key Products

Analytical Instruments  
Analytical sample conditioning products & systems  
Chemical injection fittings & valves  
Fluoropolymer chemical delivery fittings, valves & pumps  
High purity gas delivery fittings, valves, regulators & digital flow controllers  
Industrial mass flow meters/controllers  
Permanent no-weld tube fittings  
Precision industrial regulators & flow controllers  
Process control double block & bleeds  
Process control fittings, valves, regulators & manifold valves



## Sealing & Shielding

### Key Markets

Aerospace  
Chemical processing  
Consumer  
Fluid power  
General Industrial  
Information technology  
Life sciences  
Microelectronics  
Military  
Oil & gas  
Power generation  
Renewable energy  
Telecommunications  
Transportation

### Key Products

Dynamic seals  
Elastomeric o-rings  
Electro-medical instrument design & assembly  
EMI shielding  
Extruded & precision-cut, fabricated elastomeric seals  
High temperature metal seals  
Homogeneous & inserted elastomeric shapes  
Medical device fabrication & assembly  
Metal & plastic retained composite seals  
Shielded optical windows  
Silicone tubing & extrusions  
Thermal management  
Vibration dampening

# Parker Worldwide

## Europe, Middle East, Africa

### AE – United Arab Emirates, Dubai

Tel: +971 4 8127100  
parker.me@parker.com

### AT – Austria, St. Florian

Tel: +43 (0)7224 66201  
parker.austria@parker.com

### AZ – Azerbaijan, Baku

Tel: +994 50 2233 458  
parker.azerbaijan@parker.com

### BE/NL/LU – Benelux,

Hendrik Ido Ambacht  
Tel: +31 (0)541 585 000  
parker.nl@parker.com

### BG – Bulgaria, Sofia

Tel: +359 2 980 1344  
parker.bulgaria@parker.com

### BY – Belarus, Minsk

Tel: +48 (0)22 573 24 00  
parker.poland@parker.com

### CH – Switzerland, Etoy

Tel: +41 (0)21 821 87 00  
parker.switzerland@parker.com

### CZ – Czech Republic, Klecany

Tel: +420 284 083 111  
parker.czechrepublic@parker.com

### DE – Germany, Kaarst

Tel: +49 (0)2131 4016 0  
parker.germany@parker.com

### DK – Denmark, Ballerup

Tel: +45 43 56 04 00  
parker.denmark@parker.com

### ES – Spain, Madrid

Tel: +34 902 330 001  
parker.spain@parker.com

### FI – Finland, Vantaa

Tel: +358 (0)20 753 2500  
parker.finland@parker.com

### FR – France, Contamine s/Arve

Tel: +33 (0)4 50 25 80 25  
parker.france@parker.com

### GR – Greece, Piraeus

Tel: +30 210 933 6450  
parker.greece@parker.com

### HU – Hungary, Budaörs

Tel: +36 23 885 470  
parker.hungary@parker.com

### IE – Ireland, Dublin

Tel: +353 (0)1 466 6370  
parker.ireland@parker.com

### IL – Israel

Tel: +39 02 45 19 21  
parker.israel@parker.com

### IT – Italy, Corsico (MI)

Tel: +39 02 45 19 21  
parker.italy@parker.com

### KZ – Kazakhstan, Almaty

Tel: +7 7273 561 000  
parker.easteurope@parker.com

### NO – Norway, Asker

Tel: +47 66 75 34 00  
parker.norway@parker.com

### PL – Poland, Warsaw

Tel: +48 (0)22 573 24 00  
parker.poland@parker.com

### PT – Portugal

Tel: +351 22 999 7360  
parker.portugal@parker.com

### RO – Romania, Bucharest

Tel: +40 21 252 1382  
parker.romania@parker.com

### RU – Russia, Moscow

Tel: +7 495 645-2156  
parker.russia@parker.com

### SE – Sweden, Borås

Tel: +46 (0)8 59 79 50 00  
parker.sweden@parker.com

### SK – Slovakia, Banská Bystrica

Tel: +421 484 162 252  
parker.slovakia@parker.com

### SL – Slovenia, Novo Mesto

Tel: +386 7 337 6650  
parker.slovenia@parker.com

### TR – Turkey, Istanbul

Tel: +90 216 4997081  
parker.turkey@parker.com

### UA – Ukraine, Kiev

Tel: +48 (0)22 573 24 00  
parker.poland@parker.com

### UK – United Kingdom, Warwick

Tel: +44 (0)1926 317 878  
parker.uk@parker.com

### ZA – South Africa, Kempton Park

Tel: +27 (0)11 961 0700  
parker.southafrica@parker.com

## North America

### CA – Canada, Milton, Ontario

Tel: +1 905 693 3000

### US – USA, Cleveland

Tel: +1 216 896 3000

## Asia Pacific

### AU – Australia, Castle Hill

Tel: +61 (0)2-9634 7777

### CN – China, Shanghai

Tel: +86 21 2899 5000

### HK – Hong Kong

Tel: +852 2428 8008

### IN – India, Mumbai

Tel: +91 22 6513 7081-85

### JP – Japan, Tokyo

Tel: +81 (0)3 6408 3901

### KR – South Korea, Seoul

Tel: +82 2 559 0400

### MY – Malaysia, Shah Alam

Tel: +60 3 7849 0800

### NZ – New Zealand, Mt Wellington

Tel: +64 9 574 1744

### SG – Singapore

Tel: +65 6887 6300

### TH – Thailand, Bangkok

Tel: +662 186 7000

### TW – Taiwan, Taipei

Tel: +886 2 2298 8987

## South America

### AR – Argentina, Buenos Aires

Tel: +54 3327 44 4129

### BR – Brazil, Sao Jose dos Campos

Tel: +55 800 727 5374

### CL – Chile, Santiago

Tel: +56 2 623 1216

### MX – Mexico, Toluca

Tel: +52 72 2275 4200

### EMEA Product Information Centre

Free phone: 00 800 27 27 5374

(from AT, BE, CH, CZ, DE, DK, EE, ES, FI, FR, IE, IL, IS, IT, LU, MT, NL, NO, PL, PT, RU, SE, SK, UK, ZA)

### US Product Information Centre

Toll-free number: 1-800-27 27 537

www.parker.com

