



The full Product Manual is available on line at www.parker.com/ssd

890 QuickStart Manual

890SD (Standalone) Drives
Frames B, C & D with STO SIL3/PLe
HA501029U000 Issue 5

aerospace
climate control
electromechanical
filtration
fluid & gas handling
hydraulics
pneumatics
process control
sealing & shielding



ENGINEERING YOUR SUCCESS.

890

Quickstart Manual

890SD (Standalone) Drive Frames B, C & D with STO SIL3/PLe

HA501029U000 Issue 5

1) What is Safe Torque Off (STO)?

It is an electronic means of preventing the 890 drive from delivering torque and power to its connected motor. The 890 drive contains this feature as standard. It is a two channel, hardware implemented system. It has the highest possible safety rating for a variable speed drive. It is certified by BGIA, the German Trades Association for Industrial Safety, to Performance Level e (PLe) for a category 3 implementation to EN ISO 13849-1 with an equivalent Safety Integrity Level 3 (SIL 3).

All STO connections are made at terminal block X11.

2) Where Could STO be Used?

In safety control schemes for safety ratings up to category 3 PLe or SIL3. To replace expensive but less reliable drive output contactors, including for emergency stop purposes. The 890 STO function can also be used to implement Safe Stop 1 (SS1).

3) To Use the STO Function - What Should I Do Next?

Read and observe all the requirements in the STO chapter 6 of the Engineering Reference Manual, use the appropriate standards and risk assessments.

4) Replacing a NON STO Drive OR the STO Function is Not Required - What Should I Do Next?

Simply disable the STO function by Linking –

X11/01 and X11/03 to X14/03 (24V) and separately link X11/02 OR X11/04 to X14/04 (0V).

The rest of this quick start manual then applies.

5) On Start Up the MMI Displays “ ***Tripped*** SAFE TORQUE OFF” or on a 6511 MMI “ ^ASTO ” . Why?









Because no connections to X11/01 OR X11/03, they are at 0V, the STO feature has been enabled i.e. failed safe. Simply disable the STO feature by fitting the links described in item 4) above.

Contents

	<i>Page</i>
Safety	5
Hazards to Personnel	5
Application Risk	5
• Risk Assessment	6
• Accessibility	6
• Protective Insulation	6
• RCDs	6
Introduction	7
About this QuickStart	7
Installation	8
Dimensions	9
• Ventilation	9
• Environmental Conditions	9
Overview	10
3-Phase Connections	11
Motor Connections	12
890SD Control Connections	12
890SD Control Connections	13
890SD Feedback Connections	13
890SD Feedback Connections	14
Drive Start-up	15
Before Applying Power:	15
Drive Set-up	15
Motor Data	15
Quick Setup Parameters	16
Autotune	16
Running in Local	17
Running in Remote	17
Appendix A: Using the 6511 Keypad	18
The Menu Structure	19
Appendix B: Using the 6901 Keypad	20
The Menu Structure	20
The Menu Structure	21
Appendix C: Analog and Digital I/O	22
Appendix D: Electrical Ratings	25
Appendix E: Compliance	27
EMC Emissions	27
EMC Connections	27
Planning Cable Runs	28

Safety

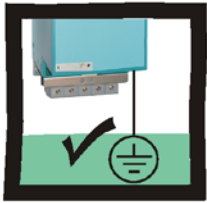
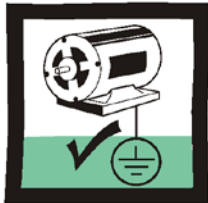
IMPORTANT Please read this information **BEFORE** installing the equipment.

 <p>This manual is for anyone installing, operating and servicing this unit.</p>	  <p>You must be technically competent to install and operate this unit.</p>	  <p>Before working on the unit, isolate the mains supply from terminals L1, L2 and L3 and wait 3 minutes.</p>	  <p>Disconnect the unit from circuits when doing high voltage resistance checks.</p>
 <p>The unit must be permanently earthed due to the high earth leakage current.</p>	 <p>The drive motor must be connected to an appropriate safety earth.</p>	 <p>Electrostatic discharge sensitive parts : observe static control precautions.</p>	 <p>Copy existing 890 parameters to any replacement 890 unit</p>

Hazards to Personnel

WARNING!

This equipment can endanger life through rotating machinery and high voltages. Failure to observe the following will constitute an **ELECTRICAL SHOCK HAZARD**.

Metal parts may reach a temperature of 70 degrees Centigrade in operation.

Before working on the equipment, ensure isolation of the mains supply from terminals L1, L2 and L3. The equipment contains high value capacitors which discharge slowly after removal of the mains supply. Wait for at least 3 minutes for the dc link terminals (DC+ and DC-) to discharge to safe voltage levels (<50V). Measure the DC+ and DC- terminal voltage with a meter to confirm that the voltage is less than 50V.

Do not apply external voltage sources (mains supply or otherwise) to any of the braking terminals (DBR+, DBR-, DC+, INT or EXT).

Application Risk

The specifications, processes and circuitry described herein are for guidance only and may need to be adapted to the user's specific application.

Parker Hannifin Manufacturing Limited does not guarantee the suitability of the equipment described in the Manual for individual applications.

Risk Assessment

Under fault conditions, power loss or other operating conditions not intended, the equipment may not operate as specified. In particular:

- The motor speed may not be controlled
- The direction of rotation of the motor may not be controlled
- The motor may be energized

If the STO feature of the 890 drive is to be used, the user must undertake a risk assessment for the application. The user must then verify that their design, which includes the 890 drive, satisfies the Performance Level (PL) or Safety Integrity Level (SIL) required by the risk assessment.

Under no circumstances must the STO feature be used without first reading and fully understanding chapter 6 (Safe Torque Off) of the Engineering Reference Manual. All safety warnings therein must be observed.

Accessibility

All live power terminals are IP20 rated only, since the equipment is intended to be installed within a normally-closed cubicle or enclosure, which itself requires a tool to open.

Protective Insulation

- All control and signal terminals are SELV, i.e. protected by double insulation. Ensure all wiring is rated for the highest system voltage.

NOTE *Thermal sensors contained within the motor must be single/basic insulated.*

- All exposed metalwork in the Drive is protected by basic insulation and bonding to a safety earth.
-

RCDs

Not recommended for use with this product. Where their use is mandatory, use only Type B RCDs (EN61009).

Caution

This is a product of the restricted sales distribution class according to IEC 61800-3. It is designated as “professional equipment” as defined in EN61000-3-2. Permission of the supply authority shall be obtained before connection to the low voltage supply.

Introduction

The 890SD Standalone Drive is designed for speed control of standard ac 3-phase motors.

- Control it remotely using configurable analogue and digital inputs and outputs.
- Control it locally using the 6511 Keypad.
- Use the Design System Explorer Configuration Tool (DSE 890) to give access to parameters, diagnostic messages, trip settings and application programming.
- Fit Options to the unit to give serial communications and closed loop speed control.

IMPORTANT *Motors used must be suitable for Inverter duty.*

About this QuickStart

This QuickStart will:

- Familiarise you with the terminals and operation of the unit.
- Provide ***basic** installation details and a quick set-up procedure.
- Show you how to Autotune the drive and start the motor.

** Because the 890 is a system product and we have no knowledge of your application, we detail the quickest way to power-up the drive using a simple earthing scheme with minimal control wiring. Refer to the full Engineering Reference Manual for items not covered in this QuickStart.*

Provided with every 890 unit is a:

- Quickstart
- 890 Installation Kit and instruction leaflet
- 6511 Keypad
- Customer-ordered Options

This QuickStart assumes that:

- You are a qualified technician with experience of installing this type of equipment.
- You are familiar with the relevant standards and Local Electric Codes (which take precedence).
- You have read and understood the Safety information provided at the front of this QuickStart.
- You realise that this guide contains only basic information and that you may need to refer to the Engineering Reference Manual to complete your installation.
- You are not using the Safe Torque Off (STO) feature of this product and that you will disable it as instructed in this QuickStart manual.
Safety Note – Use of the STO feature requires full compliance with the STO chapter 6 of the Engineering Reference Manual to which the user must first refer.

Installation

A simplified installation is shown below. This installation is **not** EMC compliant. For European installations and countries with EMC legislation refer to the 890 Engineering Reference Manual, Appendix C.

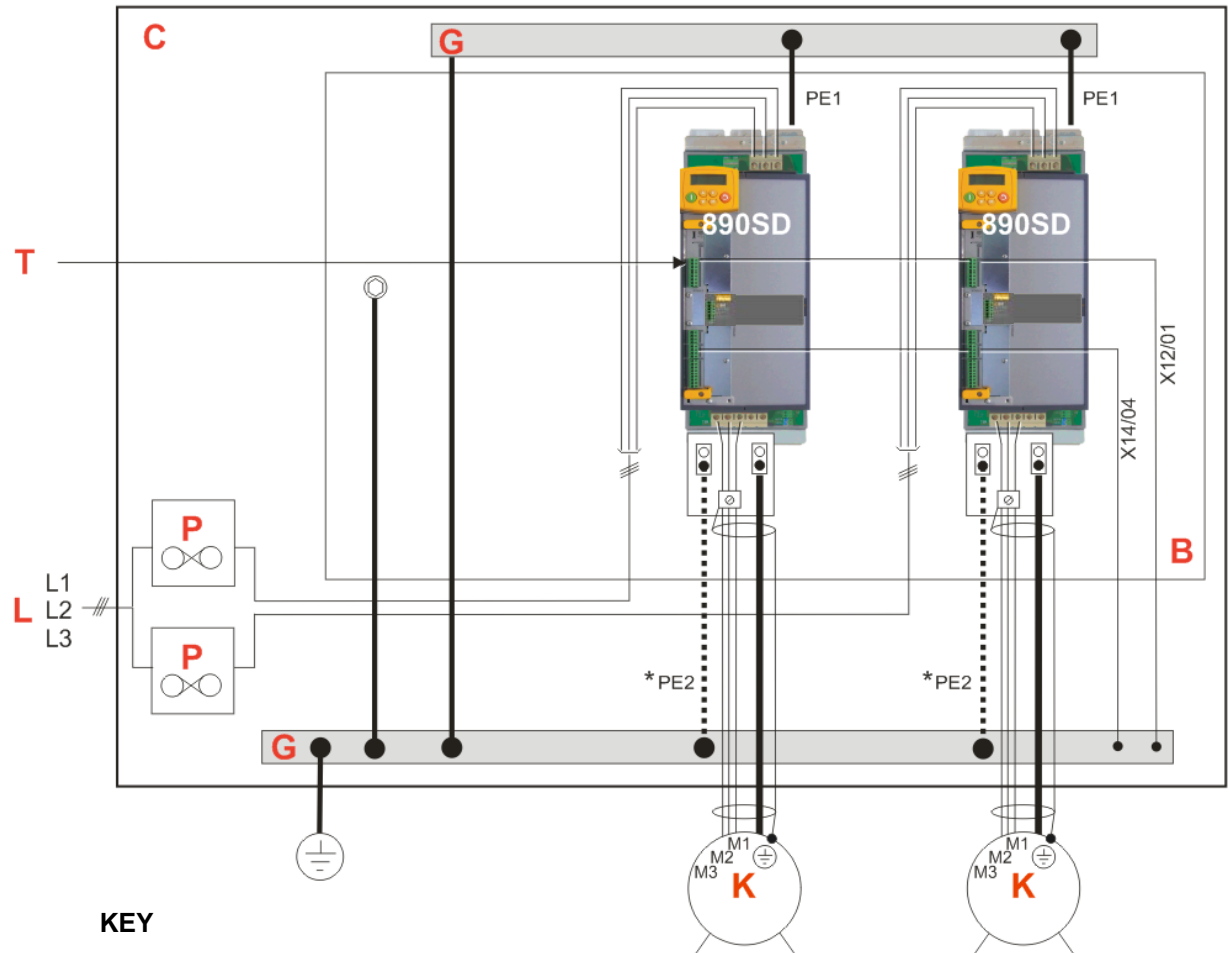

KEY

- B** Back-plate
- C** Cubicle
- G** Supply Protective Earth/Ground
- K** Motor (M1, M2, M3)
- L** 3Ø Power Supply Cable (L1, L2, L3)
- P** Fuse or circuit breaker
- T** Control Wiring terminals

890 Installation Kit

The 890 Installation Kit is shown attached to the bottom of the 890SD units in the diagram. It can also be fitted to the top of the unit.

The kit provides several options for earth/ground connections. It also includes the brackets for DIN rail mounting the unit. Refer to the instructions in the kit and use the appropriate parts.

* Permanent Earthing

The unit must be **permanently earthed** according to EN 50178: A cross-section conductor of at least 10mm² is required. This can be achieved either by using a single conductor (PE) or by laying a second conductor through separate terminals (PE2 where provided) and electrically in parallel.

Dimensions

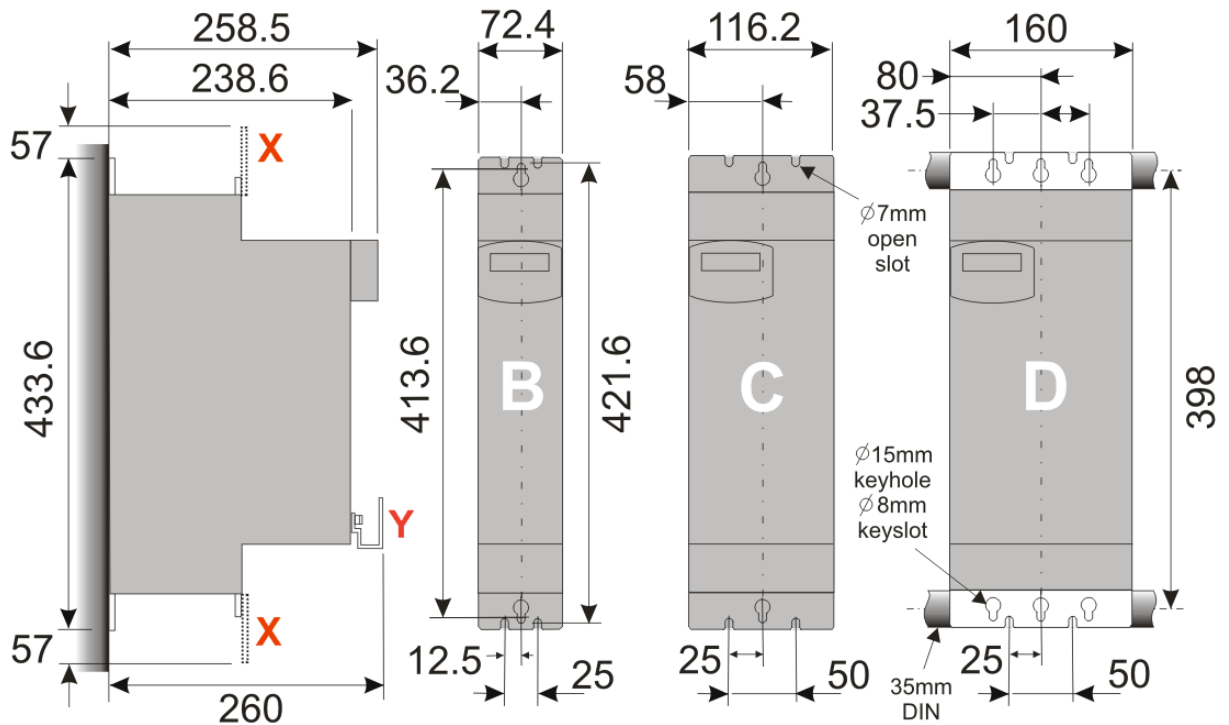

Dimensions are in millimeters (X: Power Bracket - 890 Installation Kit, Y: Control Bracket)

The units must be installed in a cubicle. Mount the drive using the keyholes and slots or on a 35mm DIN rail using the 890 Installation Kit supplied.

Ventilation

The drives can be mounted side-by-side with no clearance. A minimum of 150mm (6 inches) free-air space must be allowed at the top and bottom of each drive. If mounting drives above or below other equipment, the top and bottom distances should be added for overall clearance between drives.

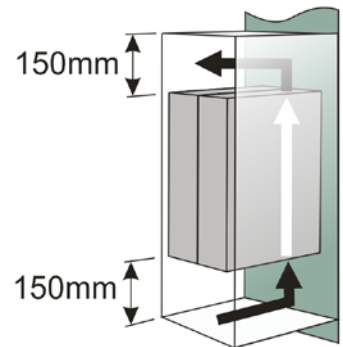

Environmental Conditions

Operating ambient temperature	0°C to 45°C (32°F to 113°F)
Enclosure rating	IP20 – UL(cUL) Open type
Atmosphere	Dust free, non flammable, non-corrosive, <85% humidity, non-condensing

Overview

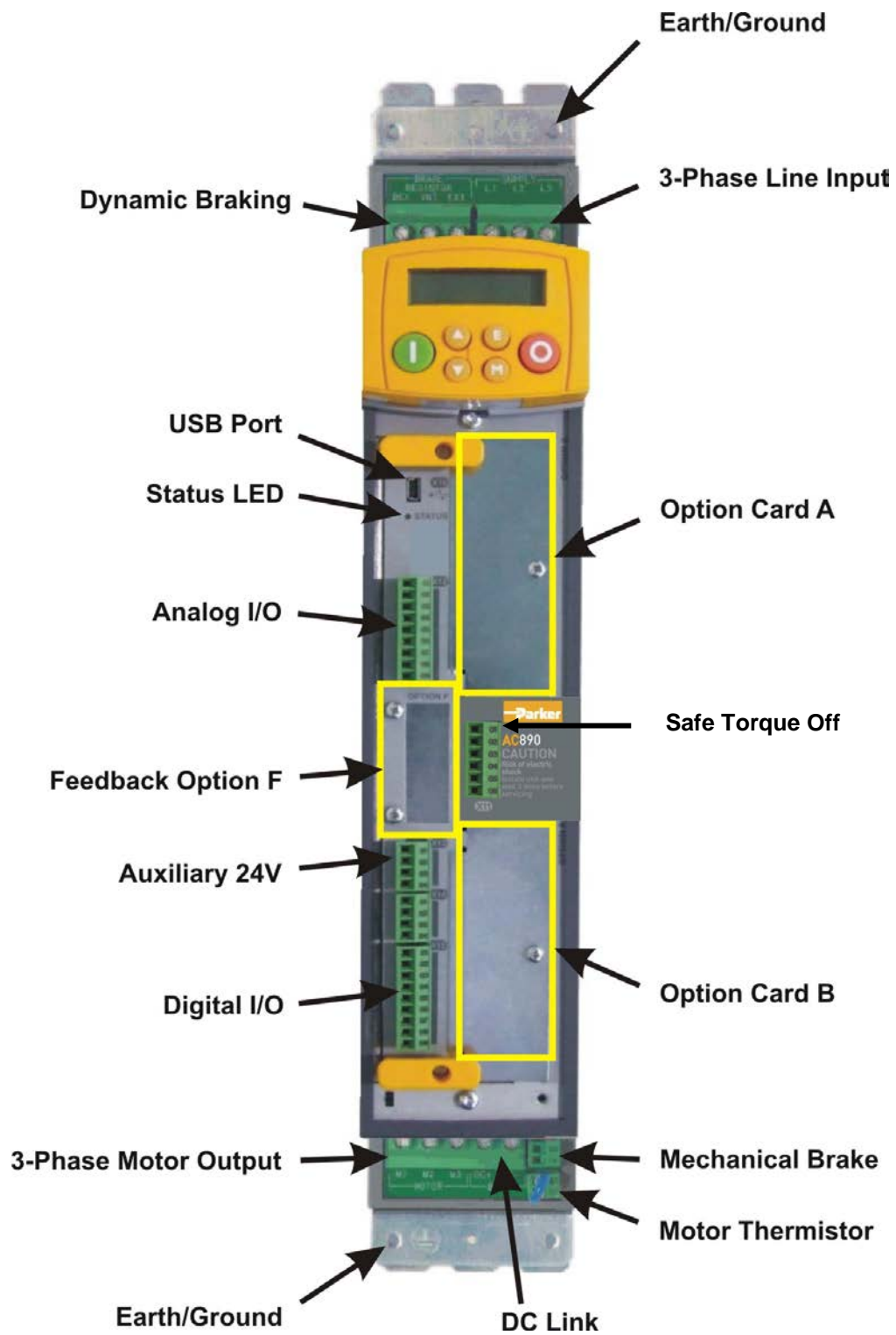

3-Phase Connections

1 Connect 3-phase power in any order to L1, L2, L3.

Maximum wire sizes:

- Frame B: 6mm²/10AWG - 0.5Nm
- Frame C: 10mm²/8AWG - 1.2Nm
- Frame D: 16mm²/4AWG - 2.4Nm

- Use branch circuit protection (circuit breaker and/or fuses)

Refer to Appendix D for Drive Rating details

2 Connect the earth/ground wire to the top ground bracket.

Maximum wire sizes:

- Frame B: 6mm²/10AWG
- Frame C: 10mm²/8AWG
- Frame D: 16mm²/4AWG

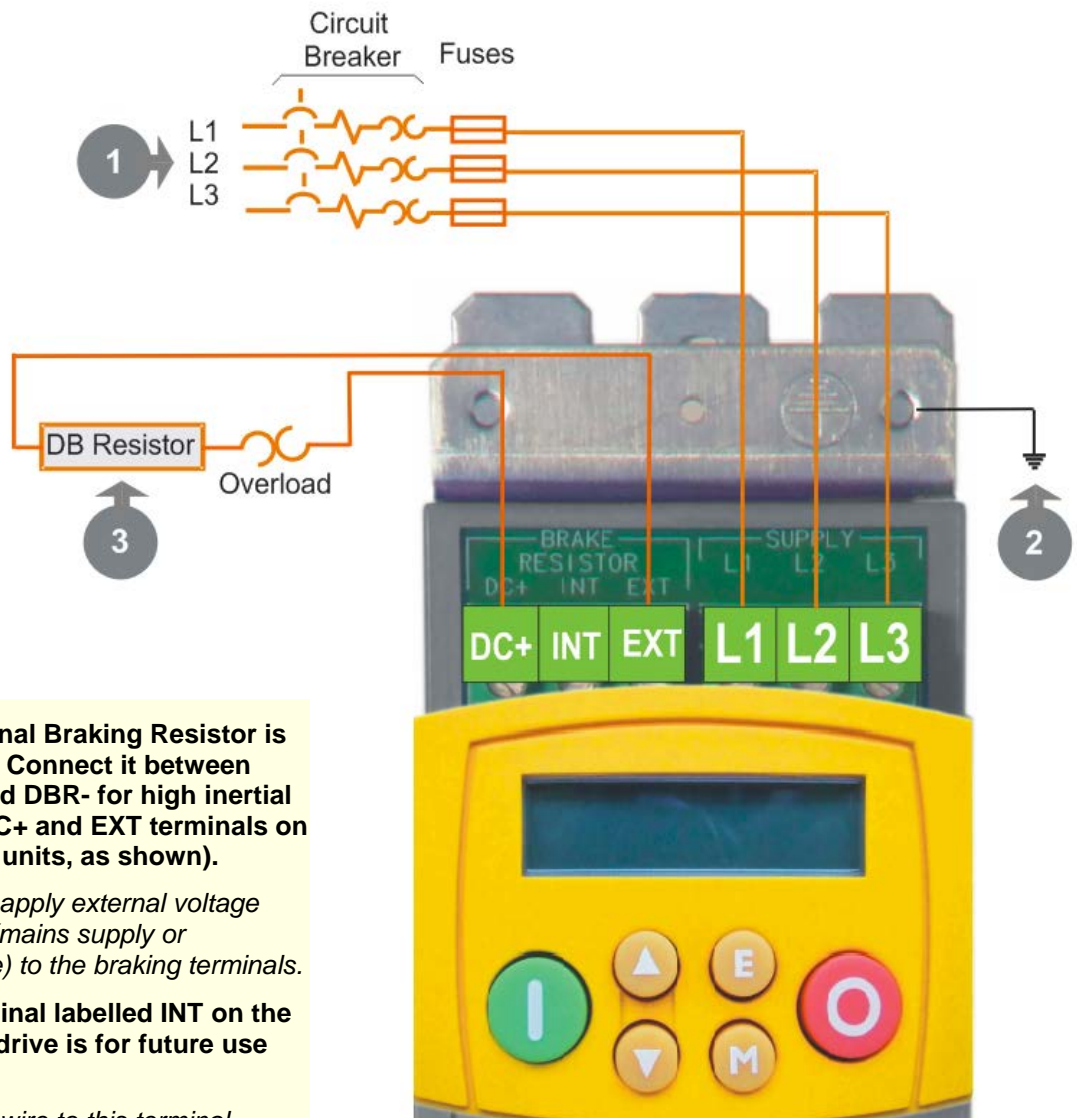

3

- An External Braking Resistor is optional. Connect it between DBR+ and DBR- for high inertial loads (DC+ and EXT terminals on Frame B units, as shown).

DO NOT apply external voltage sources (mains supply or otherwise) to the braking terminals.

- The terminal labelled INT on the frame B drive is for future use only.

DO NOT wire to this terminal.

- We recommend using a thermal overload switch to protect the braking circuit.

Motor Connections

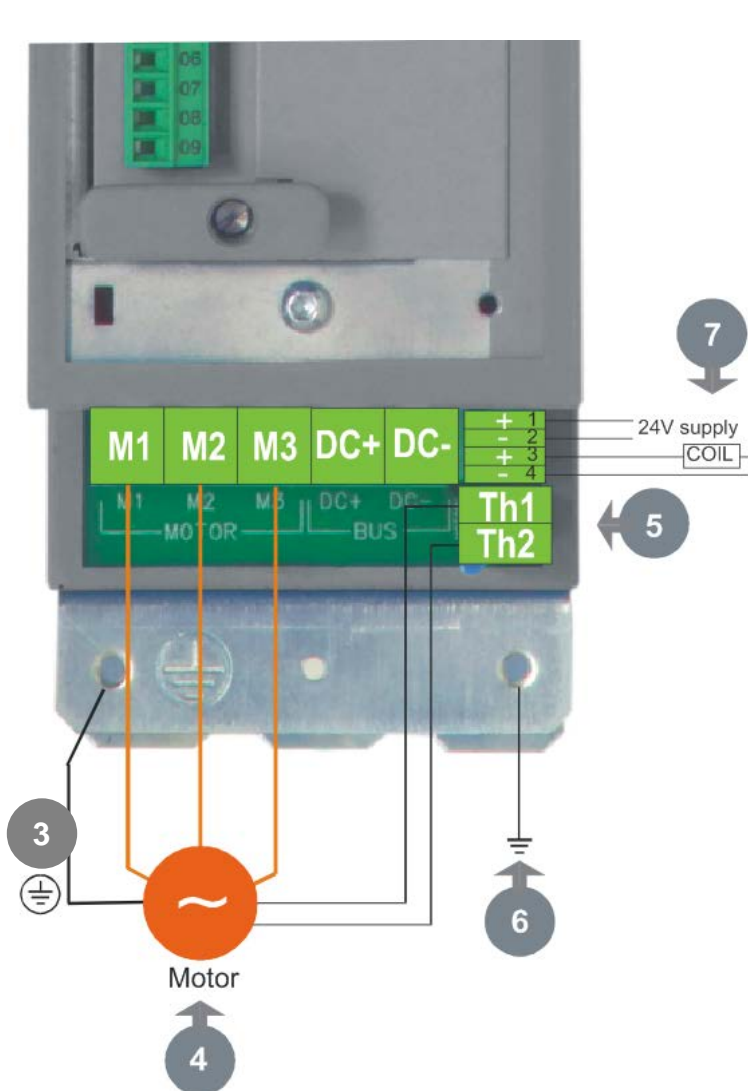

4 Connect motor leads to M1, M2, M3. Maximum wire sizes:
Frame B: 4mm²/12AWG
Frame C: 10mm²/8AWG
Frame D: 16mm²/4AWG

3 Connect the earth/ground wire from the terminal box of the motor directly to the bottom ground bracket. Maximum wire sizes:
Frame B: 4mm²/12AWG
Frame C: 10mm²/8AWG
Frame D: 16mm²/4AWG

- If not using shielded cable, run motor leads in an enclosed metal conduit grounded at both ends

5 Connect motor thermal switch or thermistor to Th1, Th2. Drive will trip when the thermal switch opens, or when the thermistor resistance exceeds 4kΩ maximum (PTC Type A : IEC 34-11 Part 2)

- If the motor does not have a protective device (thermistor), link these terminals. The drive needs the thermistor inputs connected for it to run.

6 Connect the earth/ground wire to the bottom ground bracket. Maximum wire sizes:
Frame B: 4mm²/12AWG
Frame C: 10mm²/8AWG
Frame D: 16mm²/4AWG

7 Connect the 24V DC brake supply to terminals 1 and 2, and connect the brake terminals to 3 and 4. The brake coil is energized when the drive runs.

890SD Control Connections

A Speed Reference

- Connect a 10kΩ potentiometer at terminal block X12 (Analog I/P 3)

High (CW): terminal X12/08
 Wiper: terminal X12/04
 Low (CCW): terminal X12/01

- Connect the shield to earth/ground at the bottom ground bracket

OR

- External 2-wire speed reference between terminals X12/01(-) and X12/04(+)
- Connect the shield to earth ground at the bottom ground bracket

B Sequencing

Connect volt-free contacts as required

- RUN (maintained contact) terminal X14/03 and terminal X15/02

C Safe Torque Off

To disable STO:

- Connect X14/03 to X11/01 and X11/03
- Connect X14/04 to X11/04

To use the STO feature the user must read and fully understand chapter 6 of the Engineering Reference Manual.

The control terminals will accept a single wire of size 1.5mm²/16AWG. For two wires per terminal, use smaller gauge wire such as 0.5mm²/22AWG.

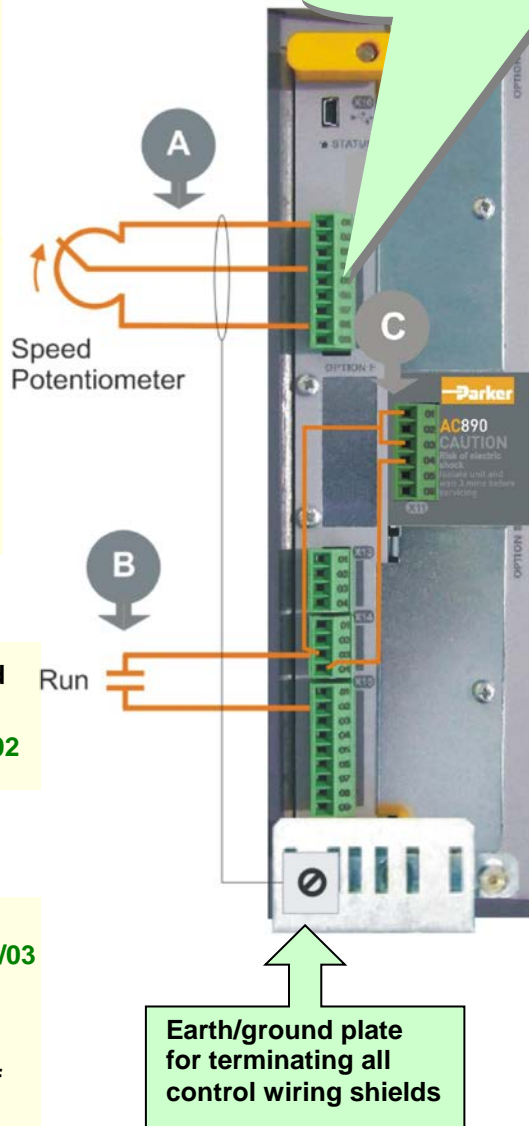

Analog

- SPEED FEEDBACK**
10V = ±100% speed at terminal X12/0 6
- TORQUE FEEDBACK**
10V = ±200% torque at terminal X12/07
- ANALOG COMMON**
0V at terminal X12/0 1

Digital

- DRIVE HEALTH**
Relay dry contact (24V rated) at terminal X14/01 and terminal X14/02
- RUNNING**
24V sourcing output at terminal X15/08
- ZERO SPEED**
24V sourcing output at terminal X15/09
- DIGITAL COMMON**
0V at terminal X14/04

This is a basic connection diagram.

For more detailed information on control connections, refer to Appendix C.

890SD Feedback Connections

This section is only for closed loop vector and induction servo applications. Skip this page if there is no encoder or resolver mounted on the motor.

Incremental Pulse Encoders

The default settings for the drive are for 2048 line, quadrature, incremental pulse encoders with differential outputs operating from a 10VDC supply.

- Z channel (Marker pulse) connections are not necessary for running the drive, but inputs are provided for positioning and servo applications. The supply voltage to the encoder is set in the Quick Setup menu. Range 10 VDC to 20 VDC

Use the Keypad to set the following options:

Supply Voltage - PULSE ENC VOLTS (S19)

Number of lines per revolution - ENCODER LINES parameter (S20)

* Encoder direction - ENCODER INVERT (S21)

* Used to match the encoder direction to the motor direction. When TRUE, changes the sign of the measured speed and the direction of the position count. It is necessary to set up this parameter when in CLOSED-LOOP VEC mode, as the encoder direction must be correct for this mode to operate.

Using other types of encoders requires the DSE Configuration Tool and the setting of other parameters. Refer to the 890 Engineering Reference Manual for details of these parameters.

Use 3-pair or 4-pair, individually shielded encoder cable, Belden model 8777 or equivalent.



OPTION F Terminal Block

- | | |
|----|------------|
| 01 | Shield |
| 02 | Supply - |
| 03 | Supply + |
| 04 | Channel Z/ |
| 05 | Channel Z |
| 06 | Channel B/ |
| 07 | Channel B |
| 08 | Channel A/ |
| 09 | Channel A |

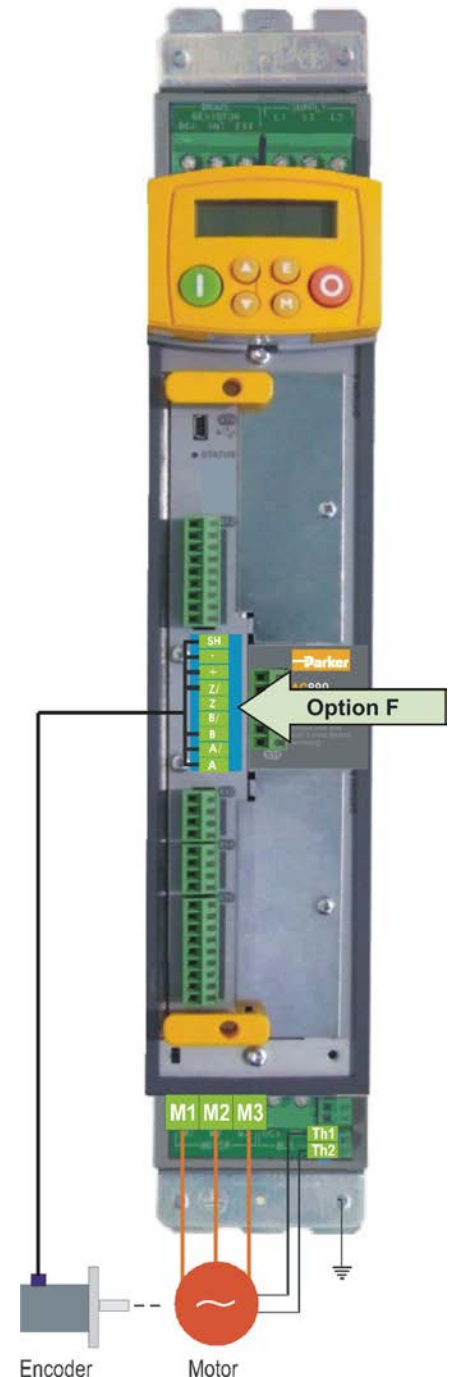

Drive Start-up

Before Applying Power:

- Read the Safety section at the front of the QuickStart.
- Ensure that all local electric codes are met.
- Check for damage to equipment.
- Check for loose ends, clippings, filings, drilling swarf etc. lodged in the drive and system.
- Check all external wiring circuits of the system - power, control, motor and earth connections.
- Ensure that unexpected rotation of the motor in either direction will not result in damage, bodily harm or injury. Disconnect the load from the motor shaft, if possible.
- Check the state of the Motor Thermistor and Brake Resistor connectors. Check external run contacts are open. Check external speed setpoints are all at zero.
- Ensure that nobody is working on another part of the system which will be affected by powering up.
- Ensure that other equipment will not be adversely affected by powering up.
- Check motor stator connections are correctly wired for Star or Delta as necessary for drive output voltage.
- Check that the STO feature has been disabled. See page 11 of this Quickstart.
- DANGER: some motors and control methods are not suitable for use with STO. Refer to chapter 6 of the Engineering Reference Manual for full details.

If all connections have been checked, it is time to POWER UP the drive.

Drive Set-up

Refer to Appendix A if using the 6511 keypad supplied with the drive. Appendix B contains information about the 6901 keypad that displays menu and parameter names in English.

Selecting Defaults

On first power-up the AC890 prompts whether to load default parameter values for 50Hz or 60Hz. Select either 50Hz or 60Hz then press M then UP to confirm the choice.

Motor Data

Before attempting to set up the drive, you will need some motor information. This is found on the motor nameplate. The information you will need is listed below:

Base Volts	Base frequency	Base RPM
Full load amps	No load amps (mag current)	Connection (star or delta)

Quick Setup Parameters

The following is a list of the Quick Setup parameters you must check before starting the drive. Set only the ones marked with "x" in the table below, under the intended mode of operation.

			V/Hz	SV	Vector
S1	Control Mode	Select the intended operating mode	x	x	x
S2	Max Speed	Motor RPM at full process speed	x	x	x
S7	V/F shape	Usually Linear. Choose fan curve only for fans	x		
S9	Motor Current	Motor full load current from motor nameplate	x	x	x
S14	Motor Base Freq	Motor nameplate frequency	x	x	x
S15	Motor Voltage	Motor nameplate voltage	x	x	x
S16	Nameplate RPM	Motor nameplate RPM	x	x	x
S17	Motor Poles	See Note		x	x
S19	Pulse Enc Volts	set between 10-20V to match encoder			x
S20	Encoder Lines	Pulses per Revolution of encoder			x
S21	Encoder Invert	Changes polarity of encoder feedback			x
S22	Autotune Enable	Drive will Autotune if started		x	x
S24	Mag Current	Enter the No-Load Amps from the motor nameplate	x	x*	x*

* if performing a Stationary Autotune.

NOTE Some of the parameters are product code dependent, that is, they are different for each frame size and power rating. For example, the unit will be set for either 50Hz or 60Hz operation:

Motor Poles for 60Hz 2 poles = 3600 rpm, 4 poles = 1800 rpm, 6 poles = 1200 rpm
Motor Poles for 50Hz 2 poles = 3000 rpm, 4 poles = 1500 rpm, 6 poles = 1000 rpm

This section is only for operating in Sensorless or Closed-loop Vector modes. If the drive is in V/Hz mode, Autotune is unnecessary and will not Enable.

Autotune

- Ensure that MAX SPEED is greater than NAMEPLATE RPM for a successful autotune.
- In the QUICK SETUP menu, set AUTOTUNE ENABLE (S22) to TRUE.
- On the 890SD keypad select LOCAL mode. Set the local setpoint, OP 1, to 0.0%.
- Press the green RUN button. The drive will begin autotuning. The drive will stop without errors if autotune is successful.
- Go to SYSTEM::SAVE CONFIG::APPLICATION and UP arrow to save your settings

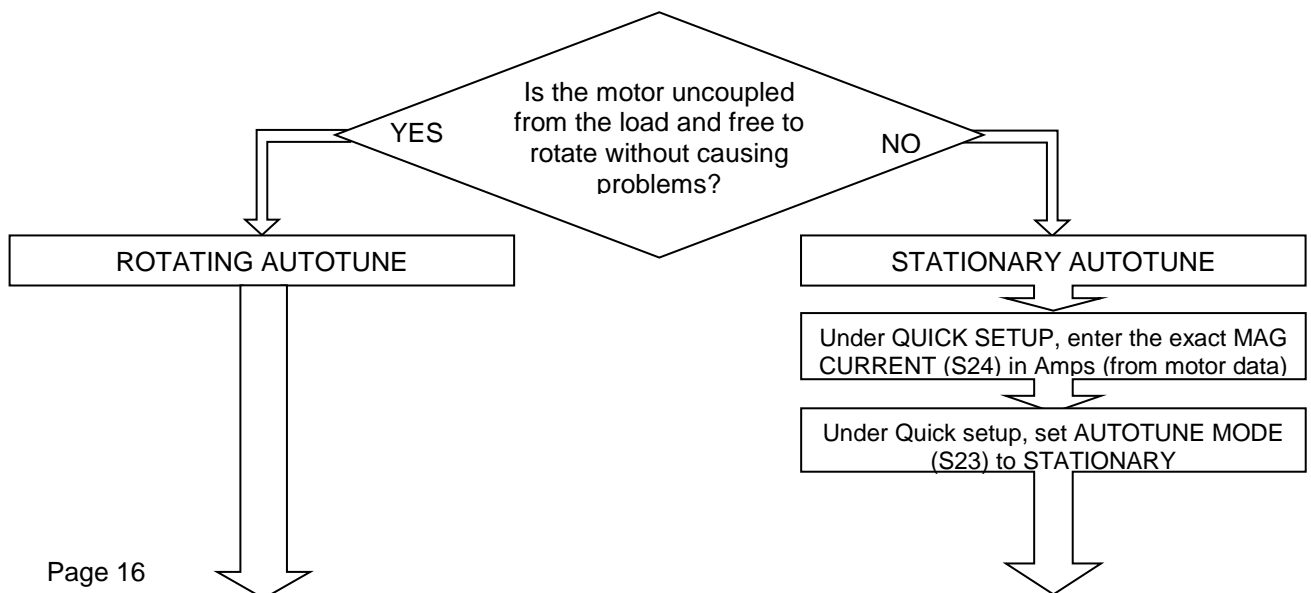

Running in Local

- On the 890SD keypad select LOCAL mode. The display will show the Local Setpoint : 0.0%
- Use the UP arrow to set a Local Setpoint, for example 20%.
- Press the green RUN button. The motor will accelerate to the desired speed and maintain it. Adjust RAMP ACCEL TIME (S3) in Quick Setup to the desired level.
- Press the red STOP button. The motor will decelerate to a stop. Adjust RAMP DECEL TIME (S4) in Quick Setup to desired level. If the drive trips on Overvoltage, extend the RAMP DECEL TIME or connect a braking resistor. Refer to the 890 Engineering Reference Manual.

Go to SYS::SAVE::APP and UP arrow to save your settings. Values are stored during power-down.

Running in Remote

- On the 890SD keypad select REMOTE mode. The display will show the remote Setpoint : ?.?% (The value displayed depends on the external speed reference).
- Dial in a speed setpoint using the Speed potentiometer until the display reads 20%.
- Start the drive by closing the Start contact between terminal X14/03 and terminal X15/02. The motor will accelerate to the desired speed and maintain it. Adjust RAMP ACCEL TIME (S4) in Quick Setup to the desired level.
- Open the Start contact. The motor will decelerate to a stop. Adjust RAMP DECEL TIME (S4) in Quick Setup to desired level. If the drive trips on Overvoltage, extend the RAMP DECEL TIME or connect a braking resistor. Refer to the 890 Engineering Reference Manual.

Go to SYS::SAVE::APP and UP arrow to save your settings. Values are stored during power-down.

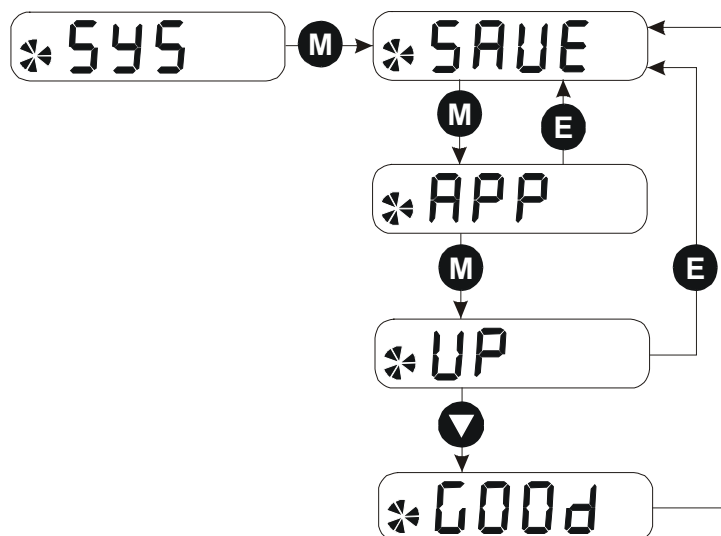

Appendix A: Using the 6511 Keypad





The 6511 is the keypad that comes as standard with any 890 product. It is a one-line backlit LCD with units and symbols for different functions. It can be used to setup and configure the 890. It can also be used to operate the drive in Local mode from its Start and Stop buttons.





From power-up, the keypad displays the Software Version, and then times-out to show the Remote Setpoint, as shown opposite.

To change Operating Mode:

You must be at the top of the MMI, showing the software version, before you can change between local and remote modes.

Mode	Action
Remote to Local	Hold the Stop key  down until LOC is displayed 
Local to Remote	Hold the Stop key  down until LOC and  are removed and the software version is displayed 

To display the software version:
Press  repeatedly to display software version.

To Start in Local Mode: Press 
To Stop in Local Mode: Press 

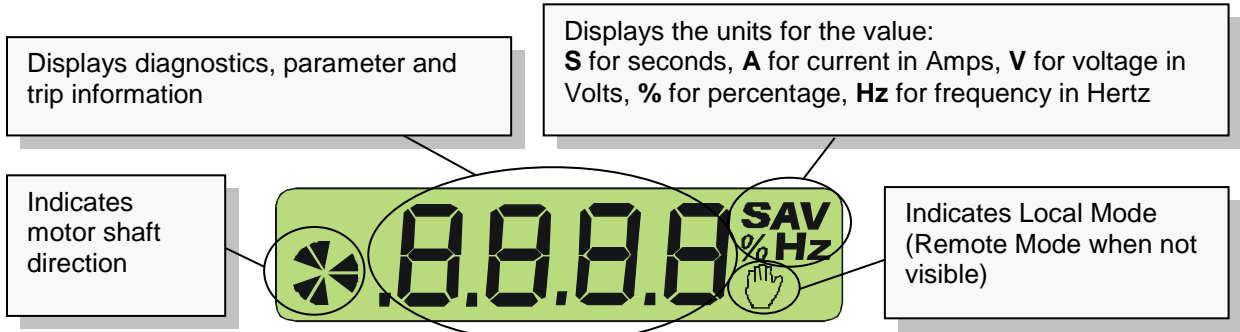

The Menu Structure

The main menus are shown below. Each menu contains parameters.



This is the power-up welcome screen. If a different screen appears, press E a few times to return to this screen



Press the M key to get to OPERATOR menu

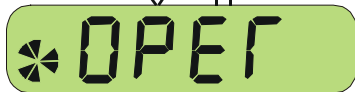

DOWN arrow to get to the DIAGNOSTICS menu

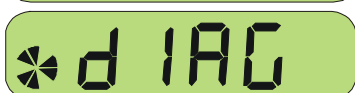

DOWN arrow to get to the QUICK SETUP menu

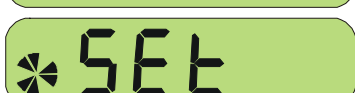



DOWN arrow to get to the SYSTEM menu



NOTE Refer to the **Engineering Reference Manual** for a list of available parameters.

How to Edit a Parameter

 Press to enter the SET::QUICKSETUP menu.

Scroll through the parameters using the  and  keys.

Press  to select a parameter for editing.

Increment/decrement the parameter value using the  and  keys.

Press  to exit the parameter.

Appendix B: Using the 6901 Keypad

The 6901 keypad can be plugged into any 890 product. It is a two-line backlit LCD display with units and symbols. It can be used to setup and configure the 890 in plain language. It can also be used to operate the drive in Local mode from its Start and Stop buttons, Jog and reverse.



SEQ and REF LEDs are On when in Local mode

To display the Software Version and Voltage Rating:

Press **E** repeatedly to display the Welcome Screen.

Press **M** to return to the Menus.

To Start in Local Mode:

Press **I**.

To Stop in Local Mode:

Press **O**.

Menus	E exit a menu	M sub-menu or parameter	▲ scroll up	▼ scroll down
Parameters	E exit parameter	M make writable	▲ previous parameter	▼ next parameter
Edit	E stop editing	M show PREF (hold)	▲ inc value	▼ dec value

To change Operating Mode:

From power-up, the keypad displays the Software Version, and then times-out to show the Remote Setpoint.

Mode	Action
Remote to Local	Toggle between modes using the L/R key L/R SEQ and REF LEDs are On when in Local
Local to Remote	Toggle between modes using the L/R key L/R SEQ and REF LEDs are Off when in Remote

The Menu Structure

The main menus are shown below. Each menu contains parameters.

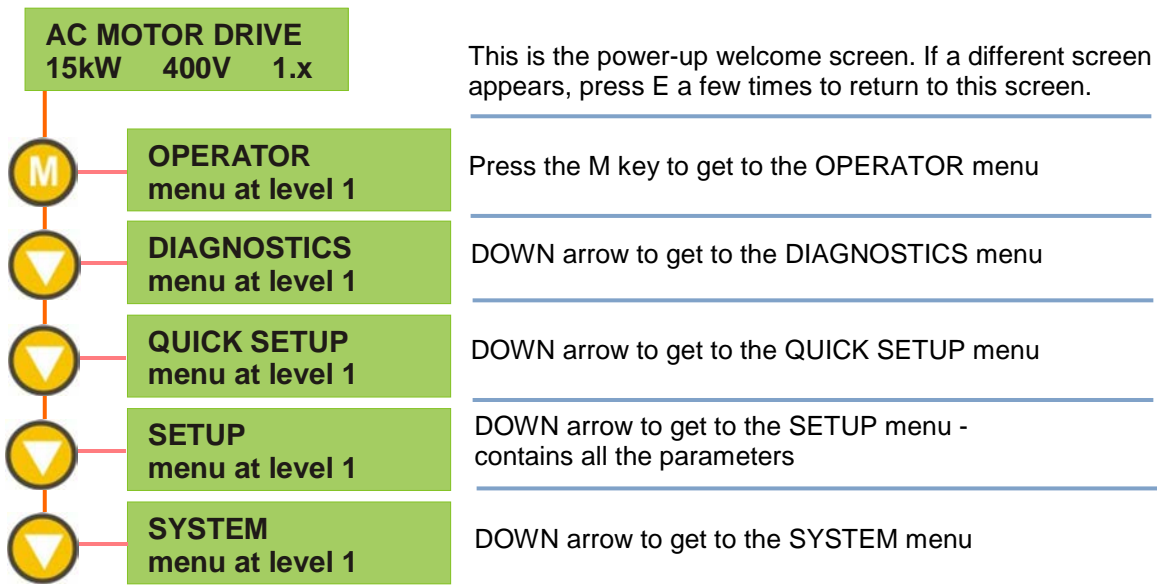

NOTE Refer to the Engineering Reference Manual for a list of available parameters.

Appendix C: Analog and Digital I/O

The terminal function names apply to the factory shipping configuration. These terminals may have different functions if the configuration has been modified using DSE.

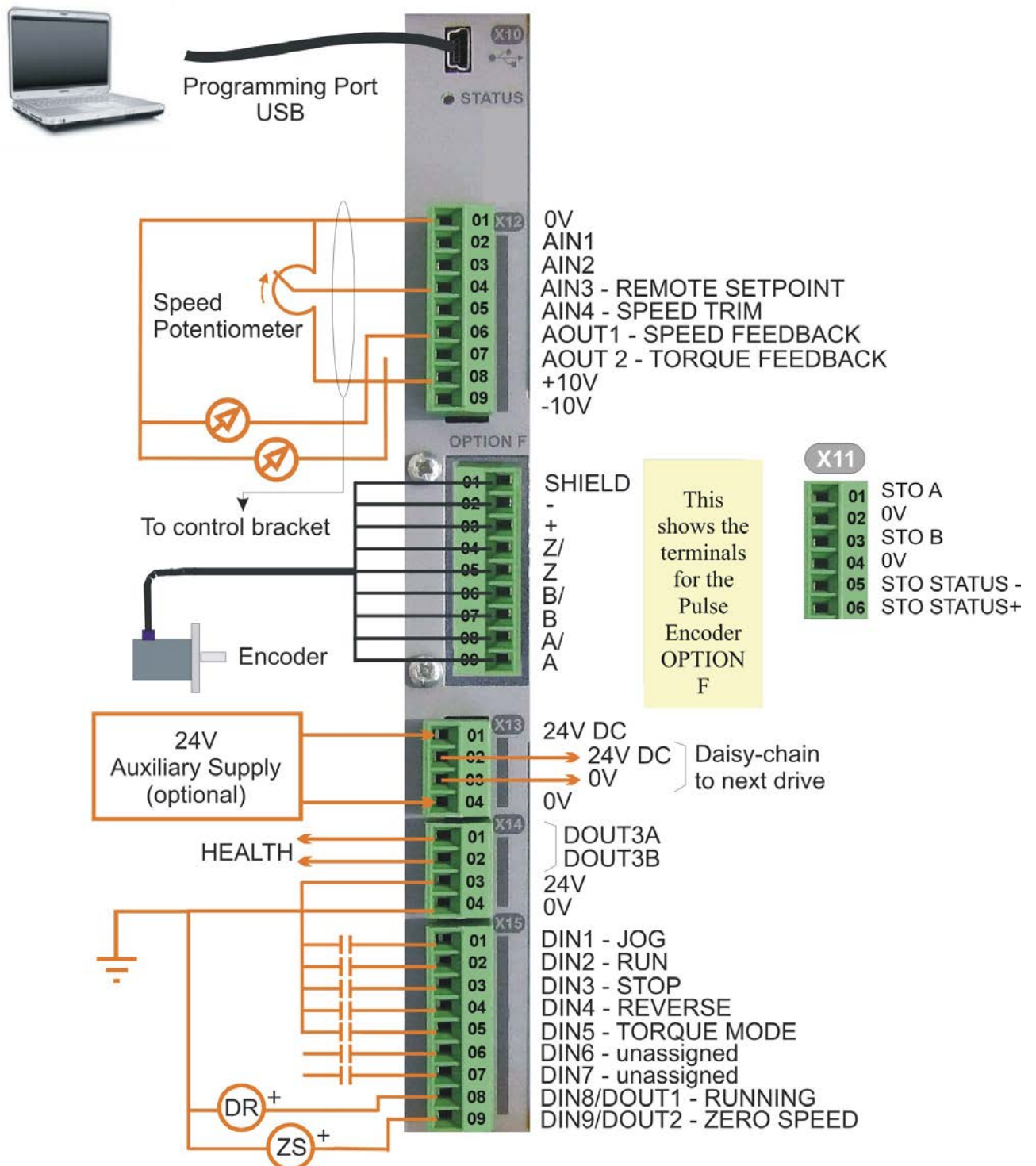

890SD Control Terminals

The terminal function names apply to the factory shipping configuration. These terminals may have different functions if the configuration has been modified using DSE.

- Analog I/O connector is X12
- Analog I/O resolution is 12 bit plus sign
- Digital I/O connector is X15
- Digital I/O is 24VDC, sourced, active high

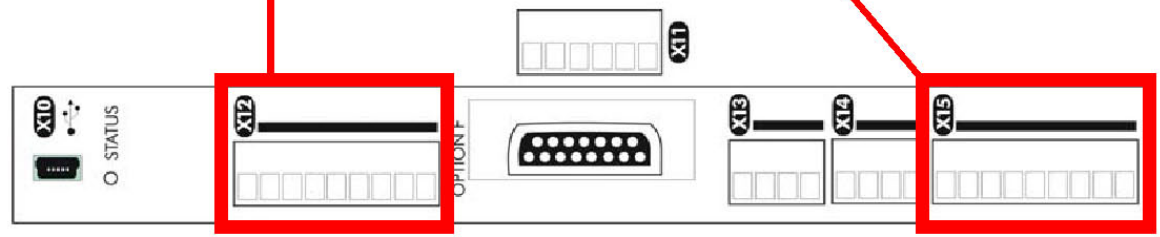

Terminal	Name	Range	Description
ANALOG I/O			
X12/01	0V		0V reference for analog I/O
X12/02	AIN1	0-10V, ±10V	Analog Input 1 Configurable (default = diff I/P +)
X12/03	AIN2	0-10V, ±10V	Analog Input 2 Configurable (default = diff I/P -)
X12/04	AIN3	±10V, 0-10V, 0-20mA, 4-20mA	Analog Input 3 Configurable (default = remote setpoint I/P)
X12/05	AIN4	±10V, 0-10V, 0-20mA, 4-20mA	Analog Input 4 Configurable (default = speed trim I/P)
X12/06	AOUT1	±10V (10V=100%speed)	Analog Output 1 Configurable (default = speed feedback O/P)
X12/07	AOUT2	±10V (10V=200% torque)	Analog Output 2 Configurable (default = torque feedback O/P)
X12/08	+10V REF	+10V	10V reference for analog i/o. Load 10mA maximum
X12/09	-10V REF	-10V	10V reference for analog i/o. Load 10mA maximum
DIGITAL I/O			
X15/01	DIN1	0 or 24V	Configurable Digital Input 1 (default = Jog)
X15/02	DIN2	0 or 24V	Configurable Digital Input 2 (default = Run)
X15/03	DIN3	0 or 24V	Configurable Digital Input 3 (default = Stop)
X15/04	DIN4	0 or 24V	Configurable Digital Input 4 (default = Reverse)
X15/05	DIN5	0 or 24V	Configurable Digital Input 5 (default = Torque mode)
X15/06	DIN6	0 or 24V	Configurable Digital Input 6 (default = Unassigned)
X15/07	DIN7	0 or 24V	Configurable Digital Input 7 (default = Unassigned)
X15/08	DIN8/DOUT1	0 or 24V	Configurable Digital Input/output (default : digital input = Running)
X15/09	DIN9/DOUT2	0 or 24V	Configurable Digital Input/output (default : digital input = Zero Speed)

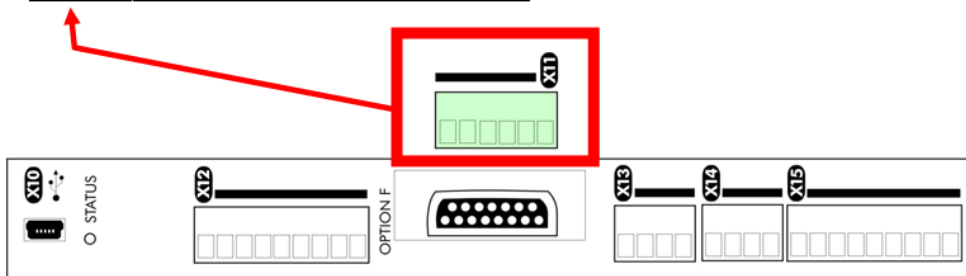

Terminal	Name	Range	Description
SAFE TORQUE OFF (STO)			
X11/01	STO A	To disable STO: connect to X14/03	 <p>To use the STO feature, the user must read and fully understand chapter 6 (Safe Torque Off) of the Engineering Reference Manual.</p>
X11/02	STO 0V	To disable STO: do not connect	
X11/03	STO B	To disable STO: connect to X14/03	
X11/04	STO 0V	To disable STO: connect to X14/04	
X11/05	STO STATUS -ve	To disable STO: do not connect	
X11/06	STO STATUS +ve	To disable STO: do not connect	

Appendix D: Electrical Ratings

		FRAME B Short circuit current rating of supply: 5000A.				
		890SD/2/0003B	890SD/2/0005B	890SD/2/0007B	890SD/2/0011B	890SD/2/0016B
890SD Standalone Drive		230				
Input currents are listed at 230Vac 50Hz, 400Vac 50Hz, and 460Vac 60Hz.						
Motor power, input current and output current ratings must not be exceeded under steady state operating conditions.						
Vector Mode 150% overload for 60 seconds. Servo Mode 200% overload for 4 seconds.						
Model Number		890SD/2/0003B	890SD/2/0005B	890SD/2/0007B	890SD/2/0011B	890SD/2/0016B
Nominal Supply Voltage	Vac					
Motor Power	kW/HP	0.55/0.75	1.1/1.5	1.5/2	2.2/3	4/5
Input Current - Vector Mode	A	4.2	7.7	9.3	15.2	21.8
Output Current - 3kHz Vector Mode	A	3	5.5	7	11	16.5
Output Current - 4kHz Servo Mode	A	2.2	4	6	8	12
Minimum External Braking Resistor	Ω	36	36	36	36	22
Model Number		890SD/5/0002B		890SD/5/0003B	890SD/5/0004B	890SD/5/0006B
Nominal Supply Voltage	Vac	400	460-500	400	460-500	400
Motor Power	kW/HP	0.55kW	0.75Hp	1.1kW	1.5Hp	1.5kW
Input Current - Vector Mode	A	2.9	2.8	5	4.9	6.8
Output Current - 3kHz Vector Mode	A	2	2	3.5	3.5	4.5
Output Current - 4kHz Servo Mode	A	1.5	1.5	2.5	2.5	3.5
Minimum External Braking Resistor	Ω	100	100	100	100	100
Model Number		890SD/5/0010B		890SD/5/0012B	890SD/5/0016B	890SD/5/S0016B
Nominal Supply Voltage	Vac	400	460-500	400	460-500	400
Motor Power	kW/HP	4kW	5Hp	5.5kW	7.5Hp	7.5kW
Input Current - Vector Mode	A	14	11.1	16.5	16.1	21.7
Output Current - 3kHz Vector Mode	A	10	8	12	12	16
Output Current - 4kHz Servo Mode	A	6	6	9	9	12
Minimum External Braking Resistor	Ω	100	100	56	56	56

* Values are for "Input Current - Servo Mode".

890SD Standalone Drive

Input currents are listed at 230Vac 50Hz, 400Vac 50Hz, and 460Vac 60Hz. Motor power, input current and output current ratings must not be exceeded under steady state operating conditions. Vector Mode 150% overload for 60 seconds. Servo Mode 200% overload for 4 seconds.

FRAME C Short circuit current rating of supply: 10000A.

Model Number	890SD/2/0024C	890SD/2/0030C	890SD/5/0024C	890SD/5/0030C	890SD/5/0030C	890SD/5/0030C
Nominal Supply Voltage	Vac	230	230	400	460-500	400 460-500
Motor Power	kW/HP	5.5/7.5	7.5/10	11kW	15Hp	15kW 20Hp
Input Current - Vector Mode	A	31	40	32	27	40 40 34
Output Current - 3kHz Vector Mode	A	24	30	24	24	30 27 30
Output Current - 4kHz Servo Mode	A	24	30	20	20	25 22 30 28
Minimum External Braking Resistor	Ω	15	12	36	36	30 30 25 25

FRAME D Short circuit current rating of supply: 10000A.

Model Number	890SD/5/0039D	890SD/5/0045D	890SD/5/0059D
Nominal Supply Voltage	Vac	400 460-500	400 460-500
Motor Power	kW/HP	18.5kW	22kW 30Hp
Input Current - Vector Mode	A	42	50 45
Output Current - 3kHz Vector Mode	A	39	45 40
Output Current - 4kHz Servo Mode	A	35	38 34
Minimum External Braking Resistor	Ω	20	20 20 15 15

Appendix E: Compliance

A comprehensive guide to product compliance is available in the full product manual.

Warning Where there is a conflict between EMC and safety requirements personnel safety shall always take precedence.

Operation of this equipment requires detailed installation and operation instructions provided in the installation/operation manual intended for use on this product.

Caution: This is a product of the restricted sales distribution class according to IEC 61800-3. It is designated as “professional equipment” as defined in EN61000-3. Permission of the supply authority shall be obtained before connection to the low voltage supply.

In a domestic environment this product may cause radio interference in which case supplementary mitigation measures may be required.

This equipment contains electrostatic discharge (ESD) sensitive parts. Observe static control precautions when handling, installing and servicing this product.

EMC Emissions

Radiated Emissions comply with EN61800-3 category C1, C2 and C3 when installed in accordance with instructions in Chapter 4 / 5 refer to “mounting the unit”.

Conducted Emissions comply with EN61800-3 category C3 without external filter and category C1 and C2 when fitted with specified external filter.

Immunity complies with the requirement of EN61800-3, for equipment intended for use in the second environment.

EMC Connections

For compliance with the EMC requirements, the “0V/signal ground” is to be separately earthed. When a number of units are used in a system, these terminals should be connected together at a single, local earthing point.

Control and signal connections should be made with screened cables, with the screen connected only at the VSD end. However, if high frequency noise is still a problem, earth screen at the non VSD end via a 0.1µF capacitor.

Note: Connect the control and signal screens (at the VSD end) to the VSD protective earth point, and not to the control board terminals.

Motor cables should have a 360° bond to ensure a low impedance connection, as per the figure below;

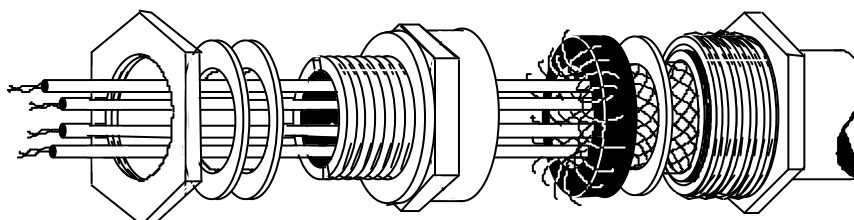

Planning Cable Runs

- ◆ Use the shortest possible motor cable lengths.
- ◆ Use a single length of cable to a star junction point to feed multiple motors.
- ◆ Keep electrically noisy and sensitive cables apart. If this is not possible parallel cable runs should be separated by at least 0.25 meters, for runs longer than 10 meters, separation should be increased proportionally.
- ◆ Sensitive cables should cross noisy cables at 90°.
- ◆ Never run sensitive cables close or parallel to the motor, dc link and braking chopper circuit for any distance.
- ◆ Never run supply, dc link or motor cables in the same bundle as the signal/control and feedback cables, even if they are screened.
- ◆ Ensure EMC filter input and output cables are separately routed and do not couple across the filter.

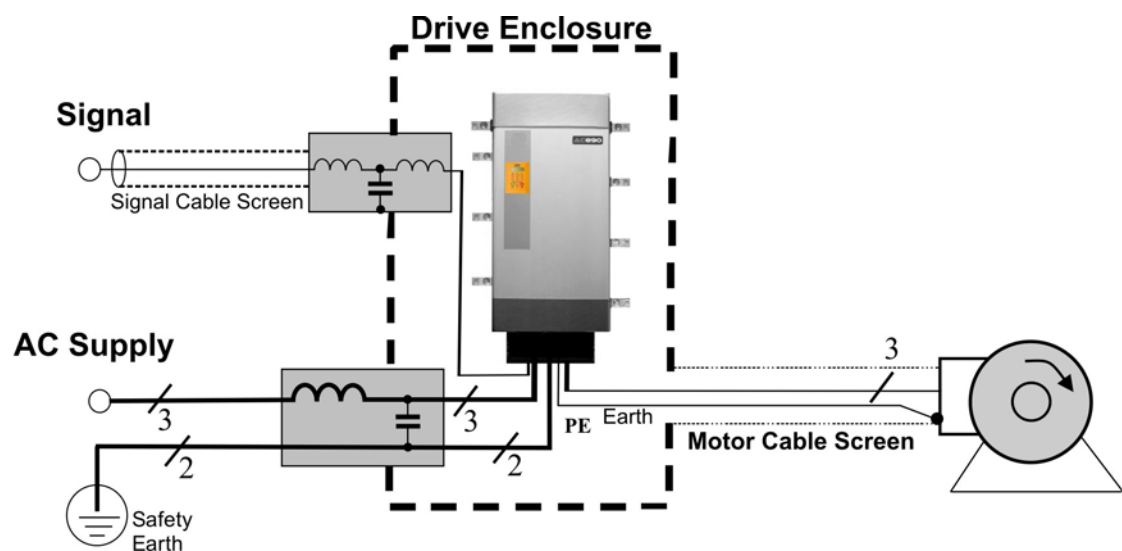

Parker Worldwide

AE – UAE, Dubai
Tel: +971 4 8127100
parker.me@parker.com

AR – Argentina, Buenos Aires
Tel: +54 3327 44 4129

AT – Austria, Wiener Neustadt
Tel: +43 (0)2622 23501-0
parker.austria@parker.com

AT – Eastern Europe, Wiener Neustadt
Tel: +43 (0)2622 23501 900
parker.easteurope@parker.com

AU – Australia, Castle Hill
Tel: +61 (0)2-9634 7777

AZ – Azerbaijan, Baku
Tel: +994 50 2233 458
parker.azerbaijan@parker.com

BE/LU – Belgium, Nivelles
Tel: +32 (0)67 280 900
parker.belgium@parker.com

BR – Brazil, Cachoeirinha RS
Tel: +55 51 3470 9144

BY – Belarus, Minsk
Tel: +375 17 209 9399
parker.belarus@parker.com

CA – Canada, Milton, Ontario
Tel: +1 905 693 3000

CH – Switzerland, Etoy
Tel: +41 (0)21 821 87 00
parker.switzerland@parker.com

CL – Chile, Santiago
Tel: +56 2 623 1216

CN – China, Shanghai
Tel: +86 21 2899 5000

CZ – Czech Republic, Klecany
Tel: +420 284 083 111
parker.czechrepublic@parker.com

DE – Germany, Kaarst
Tel: +49 (0)2131 4016 0
parker.germany@parker.com

DK – Denmark, Ballerup
Tel: +45 43 56 04 00
parker.denmark@parker.com

ES – Spain, Madrid
Tel: +34 902 330 001
parker.spain@parker.com

FI – Finland, Vantaa
Tel: +358 (0)20 753 2500
parker.finland@parker.com

FR – France, Contamine s/Arve
Tel: +33 (0)4 50 25 80 25
parker.france@parker.com

GR – Greece, Athens
Tel: +30 210 933 6450
parker.greece@parker.com

HK – Hong Kong
Tel: +852 2428 8008

HU – Hungary, Budapest
Tel: +36 1 220 4155
parker.hungary@parker.com

IE – Ireland, Dublin
Tel: +353 (0)1 466 6370
parker.ireland@parker.com

IN – India, Mumbai
Tel: +91 22 6513 7081-85

IT – Italy, Corsico (MI)
Tel: +39 02 45 19 21
parker.italy@parker.com

JP – Japan, Tokyo
Tel: +81 (0)3 6408 3901

KR – South Korea, Seoul
Tel: +82 2 559 0400

KZ – Kazakhstan, Almaty
Tel: +7 7272 505 800
parker.easteurope@parker.com

MX – Mexico, Apodaca
Tel: +52 81 8156 6000

MY – Malaysia, Shah Alam
Tel: +60 3 7849 0800

NL – The Netherlands, Oldenzaal
Tel: +31 (0)541 585 000
parker.nl@parker.com

NO – Norway, Asker
Tel: +47 66 75 34 00
parker.norway@parker.com

NZ – New Zealand, Mt Wellington
Tel: +64 9 574 1744

PL – Poland, Warsaw
Tel: +48 (0)22 573 24 00
parker.poland@parker.com

PT – Portugal, Leca da Palmeira
Tel: +351 22 999 7360
parker.portugal@parker.com

RO – Romania, Bucharest
Tel: +40 21 252 1382
parker.romania@parker.com

RU – Russia, Moscow
Tel: +7 495 645-2156
parker.russia@parker.com

SE – Sweden, Spånga
Tel: +46 (0)8 59 79 50 00
parker.sweden@parker.com

SG – Singapore
Tel: +65 6887 6300

SK – Slovakia, Banská Bystrica
Tel: +421 484 162 252
parker.slovakia@parker.com

SL – Slovenia, Novo Mesto
Tel: +386 7 337 6650
parker.slovenia@parker.com

TH – Thailand, Bangkok
Tel: +662 717 8140

TR – Turkey, Istanbul
Tel: +90 216 4997081
parker.turkey@parker.com

TW – Taiwan, Taipei
Tel: +886 2 2298 8987

UA – Ukraine, Kiev
Tel: +380 44 494 2731
parker.ukraine@parker.com

UK – United Kingdom, Warwick
Tel: +44 (0)1926 317 878
parker.uk@parker.com

US – USA, Cleveland
Tel: +1 216 896 3000

VE – Venezuela, Caracas
Tel: +58 212 238 5422

ZA – South Africa, Kempton Park
Tel: +27 (0)11 961 0700
parker.southafrica@parker.com

European Product Information Centre

Free phone: 00 800 27 27 5374

(from AT, BE, CH, CZ, DE, EE, ES, FI, FR, IE, IL, IS, IT, LU, MT, NL, NO, PT, SE, SK, UK)

© 2017 Parker Hannifin Corporation. All rights reserved.

**Parker Hannifin Manufacturing Limited, Automation Group,
Electromechanical Business Unit,
New Courtwick Lane, Littlehampton,
West Sussex BN17 7RZ
United Kingdom
Tel: +44(0)1903 737000
Fax: +44(0)1903 737100
www.parker.com/ssd**

